

Rohrkabelschuhe

handelsüblich

120 mm² M10

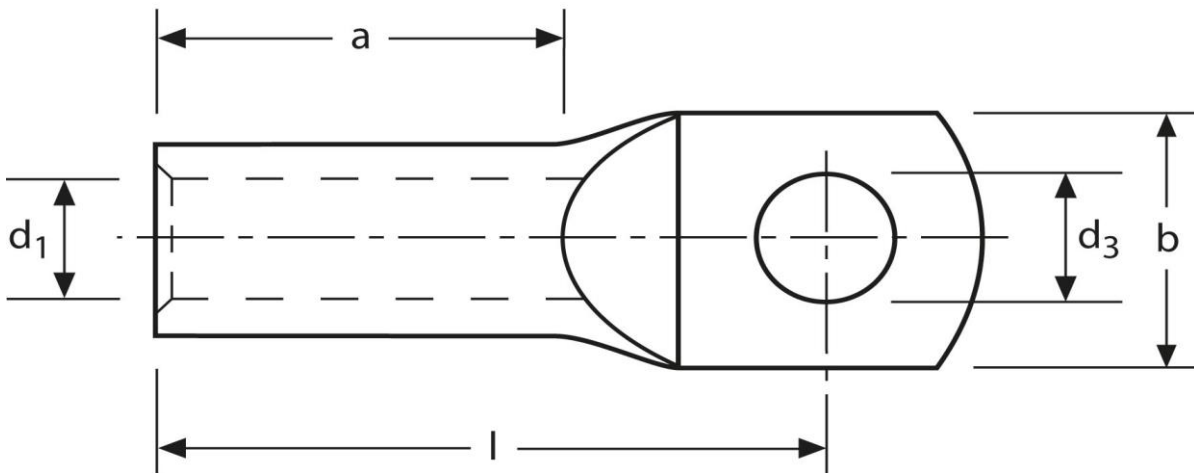

Art.Nr.	Werkstoff	Oberfläche		
K343100	E-CU	galv. Sn	65,7/ 1000	10
	d₃	d₁	b	
in mm:	10,5	15,0	29,0	
	l	a		
in mm:	50,0	26		

Stand: 19.11.2014

Tubular cable-lugs
commercial
120 mm² M10

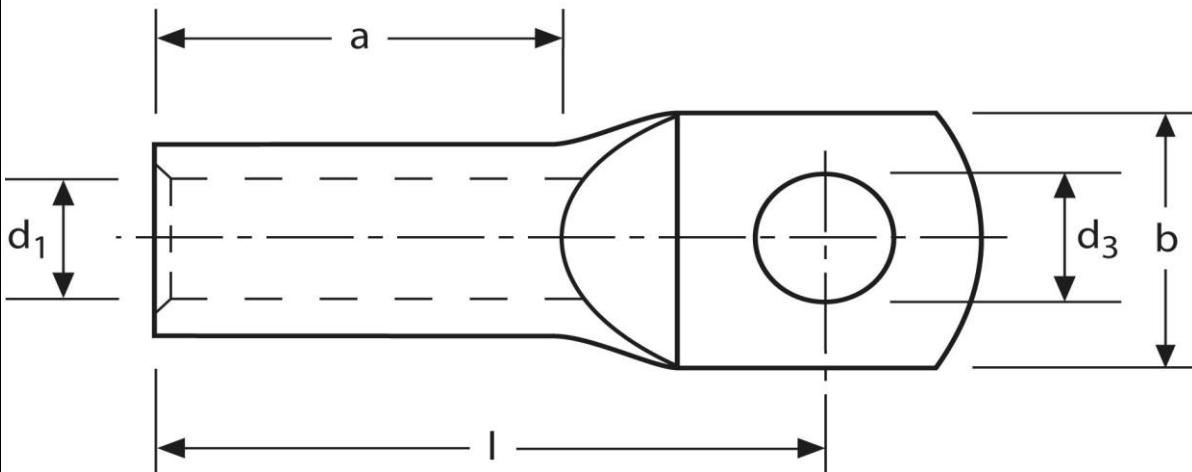

part no.	material	surface		
K343100	E-CU	tin-plated	65,7/ 1000	10
	d₃	d₁	b	
in mm:	10,5	15,0	29,0	
	l	a		
in mm:	50,0	26		

date: 19.11.2014