

Rohrkabelschuhe

handelsüblich

25 mm² M6

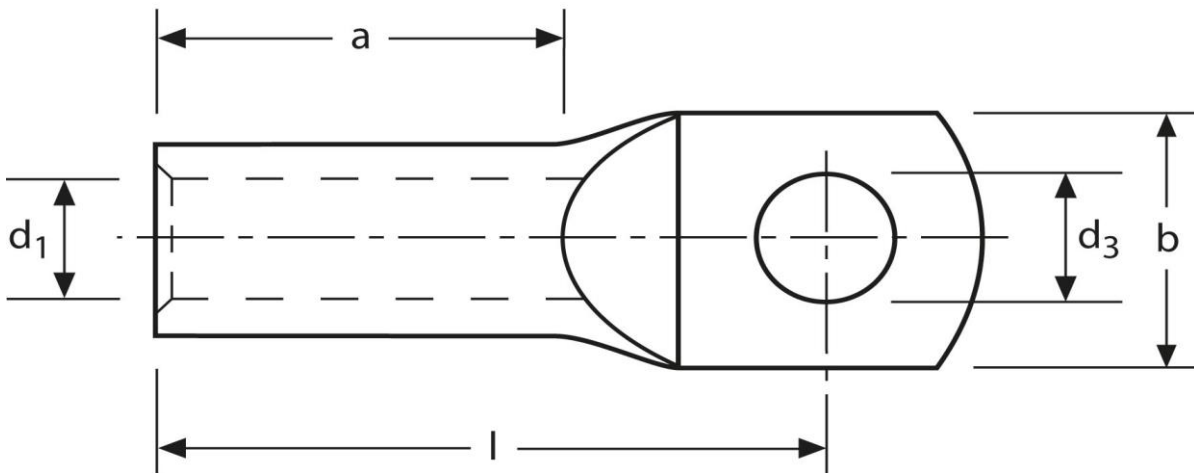

Art.Nr.	Werkstoff	Oberfläche		
K338060	E-CU	galv. Sn	12,2/ 1000	100
	d ₃	d ₁	b	
in mm:	6,5	7,0	14,0	
	l	a		
in mm:	28,5	15		

Stand: 13.11.2014

Tubular cable-lugs
 commercial
 25 mm² M6

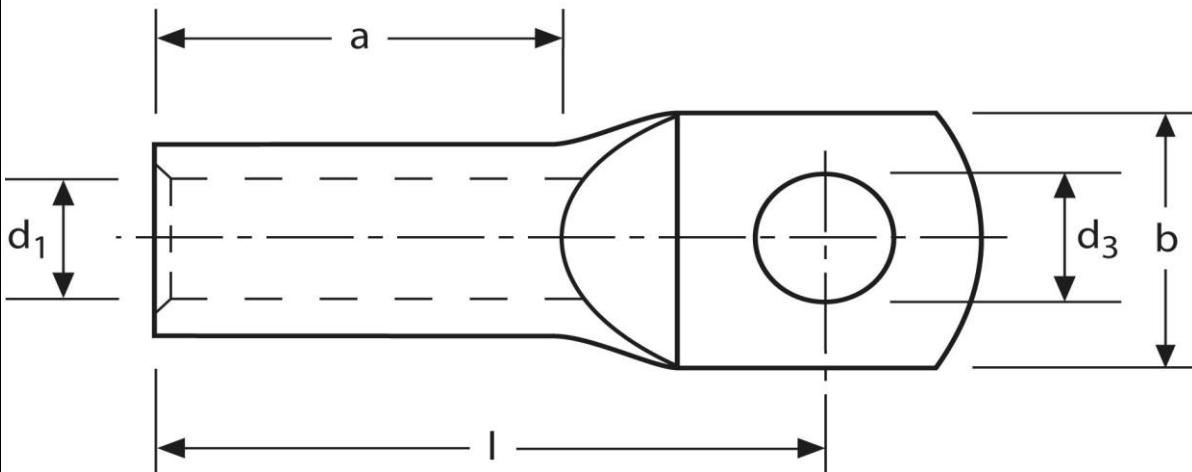

part no.	material	surface		
K338060	E-CU	tin-plated	12,2/ 1000	100
	d₃	d₁	b	
in mm:	6,5	7,0	14,0	
	l	a		
in mm:	28,5	15		

date: 13.11.2014