

## Quetschkabelschuhe

Ringform  
120 mm<sup>2</sup> M 12

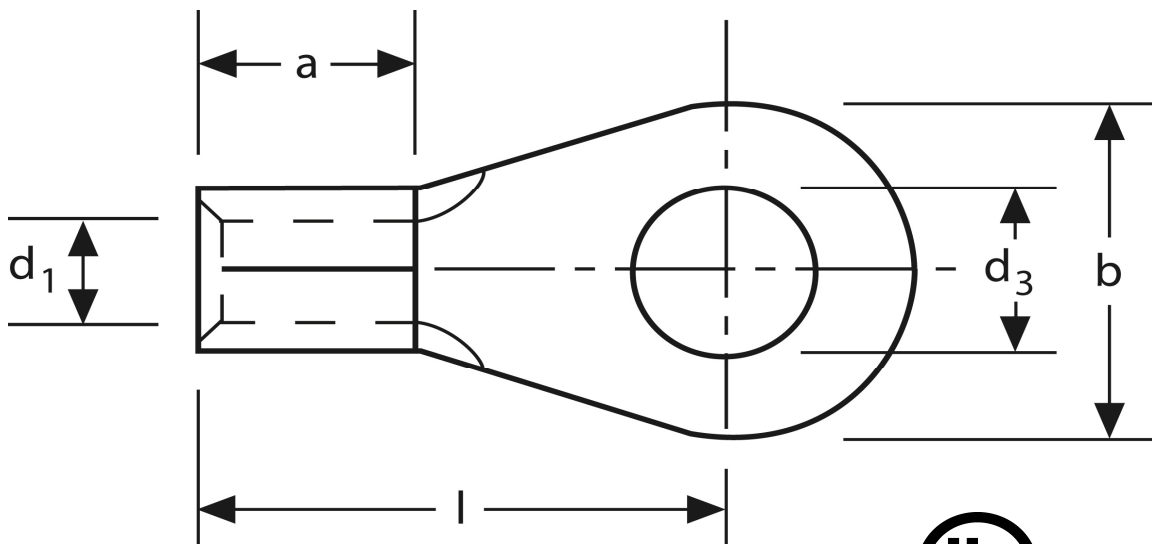

Art.Nr.	Werkstoff	Oberfläche		
K 311120	E-CU	galv. Sn	54,0 / 1000	25
	<b>d<sub>3</sub></b>	<b>d<sub>1</sub></b>	<b>b</b>	
<b>in mm:</b>	13,0	16,5	24	
	<b>l</b>	<b>a</b>	<b>s</b>	
<b>in mm:</b>	44	22	3,0	

Stand: 08.07.2014

**Solderless terminals**  
ring-type  
120 mm<sup>2</sup> M 12

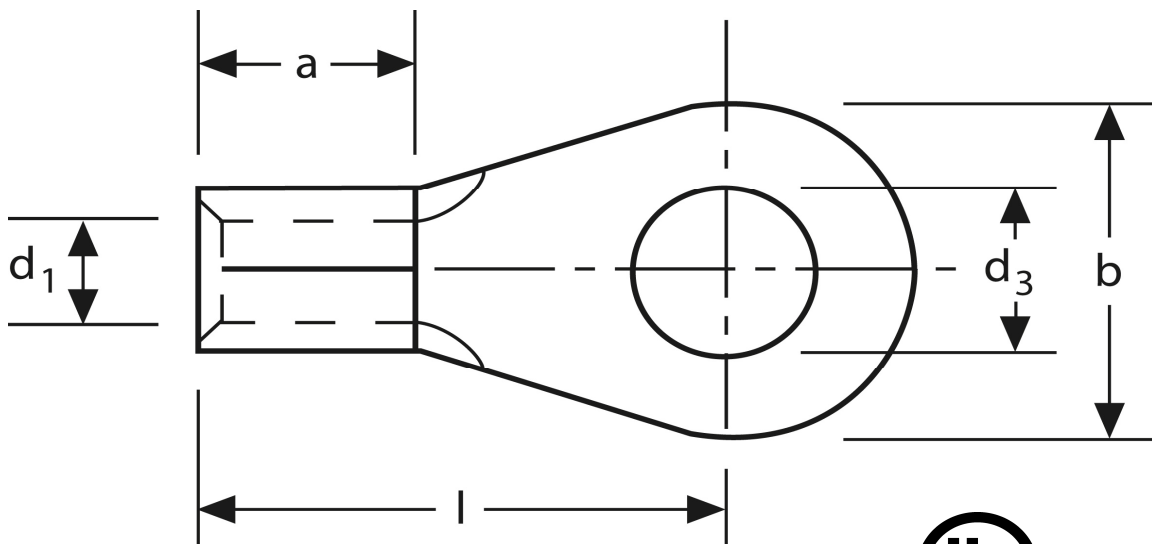

part no.	material	surface		
K 311120	E-CU	tin-plated	54,0 / 1000	25
	<b>d<sub>3</sub></b>	<b>d<sub>1</sub></b>	<b>b</b>	
<b>in mm:</b>	13,0	16,5	24	
	<b>l</b>	<b>a</b>	<b>s</b>	
<b>in mm:</b>	44	22	3,0	

date: 08.07.2014