

Quetschkabelschuhe

Ringform
120 mm² M 8

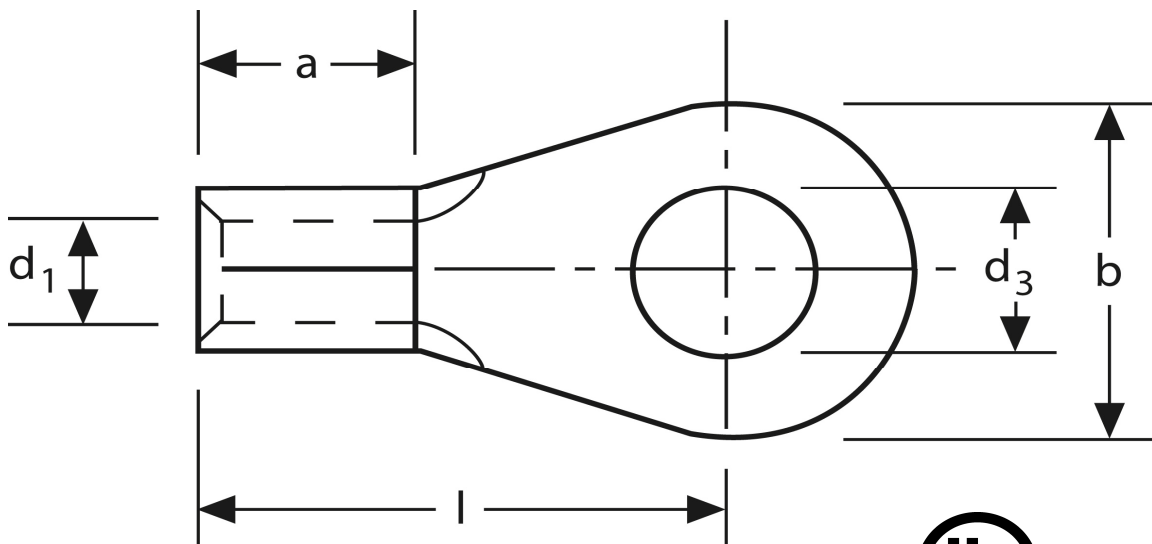

Art.Nr.	Werkstoff	Oberfläche		
K 311080	E-CU	galv. Sn	57,0 / 1000	25
	d ₃	d ₁	b	
in mm:	8,4	16,5	24	
	l	a	s	
in mm:	44	22	3,0	

Stand: 08.07.2014

Solderless terminals
ring-type
120 mm² M 8

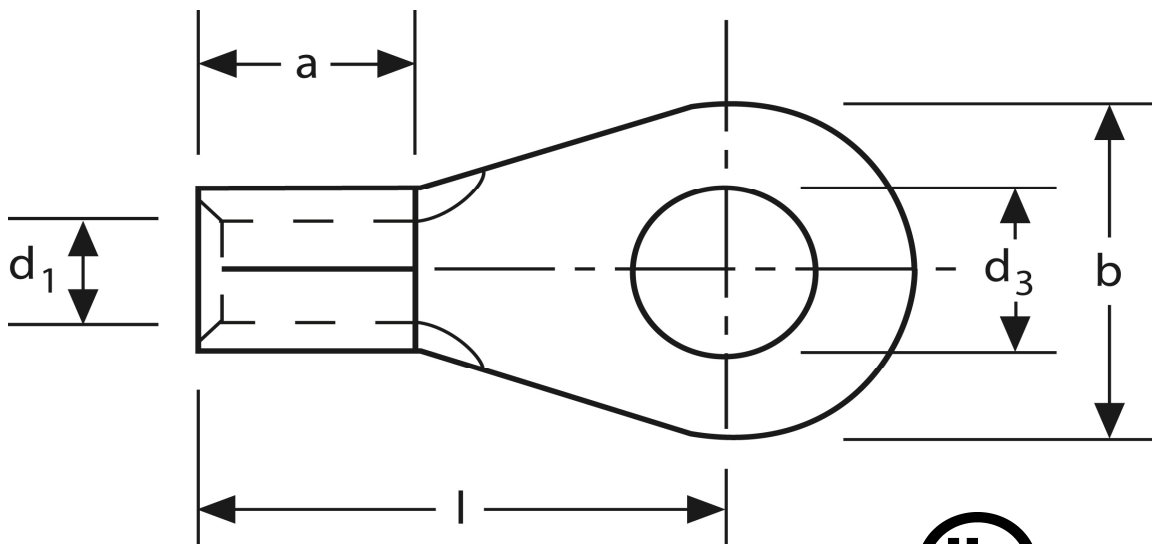

part no.	material	surface		
K 311080	E-CU	tin-plated	57,0 / 1000	25
	d₃	d₁	b	
in mm:	8,4	16,5	24	
	l	a	s	
in mm:	44	22	3,0	

date: 08.07.2014