

Quetschkabelschuhe

Ringform
16 mm² M 6

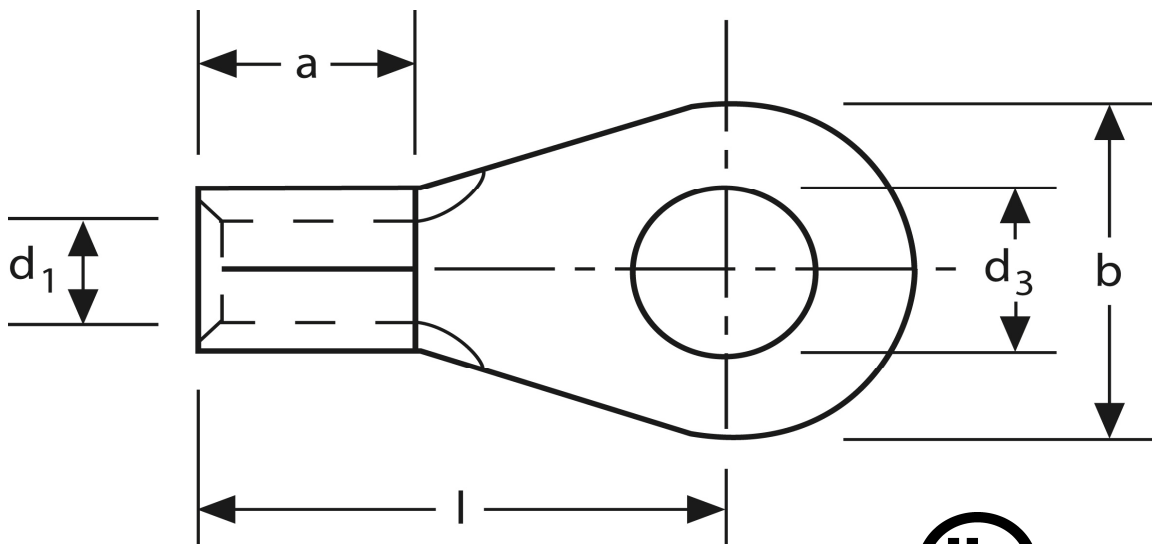

Art.Nr.	Werkstoff	Oberfläche		
K 305060	E-CU	galv. Sn	3,80 / 1000	500
	d ₃	d ₁	b	
in mm:	6,5	5,8	11	
	l	a	s	
in mm:	20	10	1,2	

Stand: 08.07.2014

Solderless terminals
ring-type
16 mm² M 6

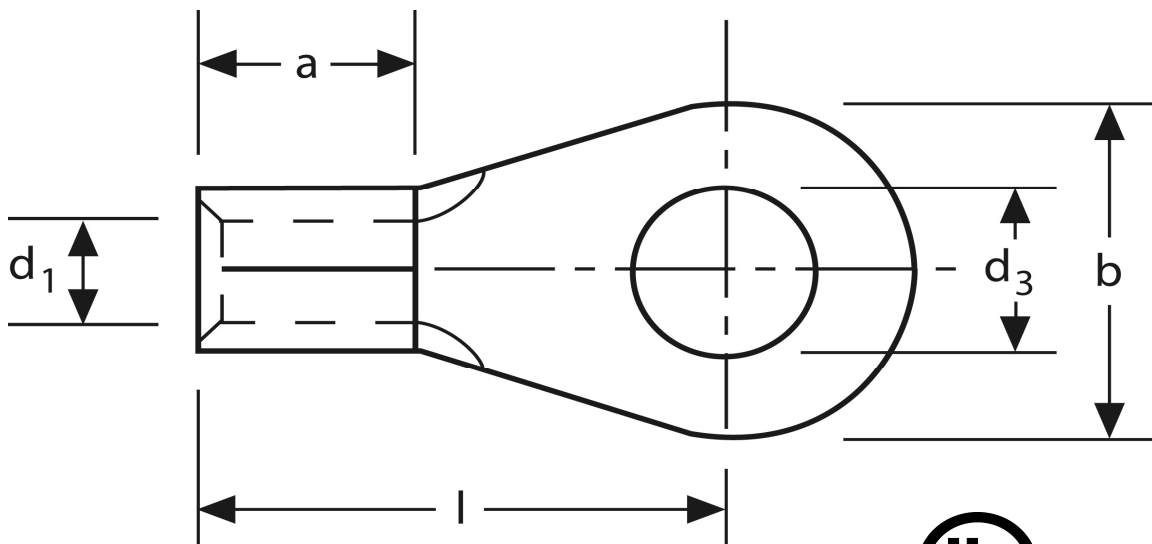

part no.	material	surface		
K 305060	E-CU	tin-plated	3,80 / 1000	500
	d₃	d₁	b	
in mm:	6,5	5,8	11	
	l	a	s	
in mm:	20	10	1,2	

date: 08.07.2014