

## Kabelbinder Pan-Steel

AISI 316, beschichtet

521 - 7,9 mm

weiß

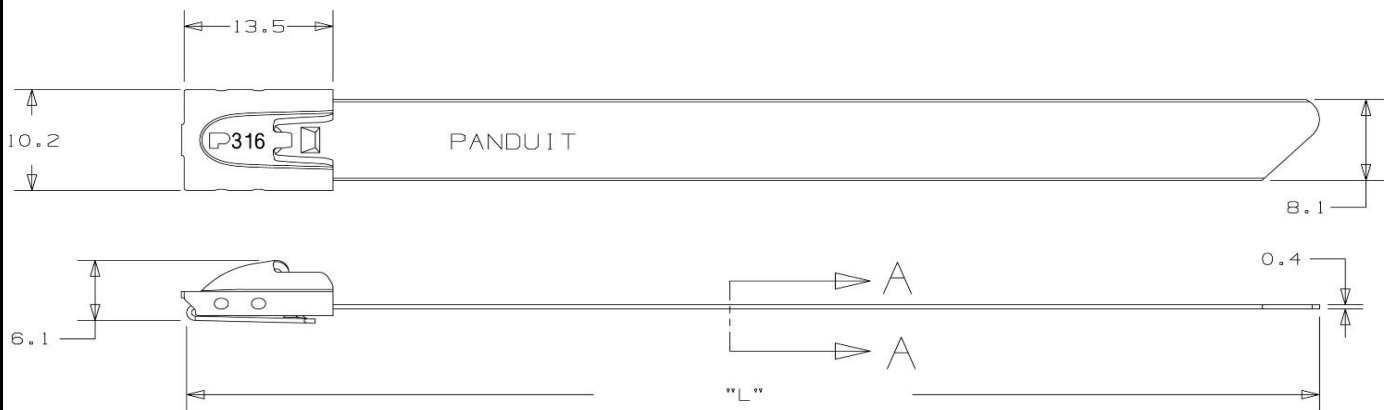

Art.Nr.	Werkstoff	Beschichtung
PA-MLTFC6H-LP316WH	Edelstahl AISI 316	Polyester, weiß
	<b>L</b>	Kabelbaum max.
<b>in mm:</b>	<b>521</b>	<b>152</b>
	<b>Temperaturbereich</b>	<b>Zugfestigkeit</b>
	<b>-40°C bis + 150°C</b>	<b>min. 1112 N</b>

Stand: 02.01.2017