

Quetschkabelschuhe

Ringform

A.W.G. 8 (10 mm²) M 8

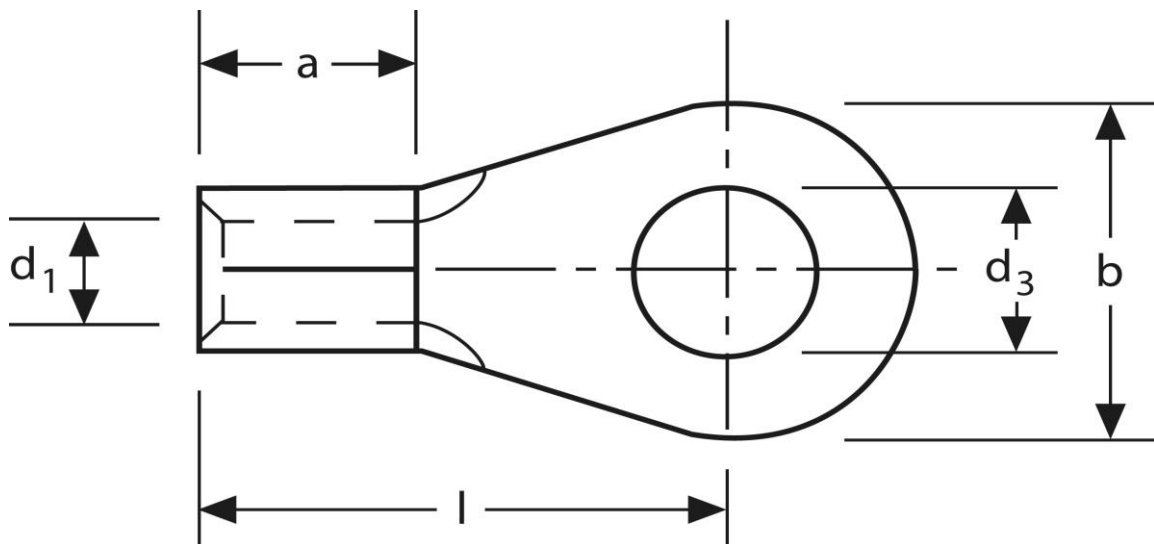

Art.Nr.	Werkstoff	Oberfläche		
K 304080.2	E-CU	galv. Sn	2,90 / 1000	500
	d ₃	d ₁	b	
in mm:	8,4	4,5	15	
	l	a	s	
in mm:	22,3	8,5	1,2	

Stand: 24.01.2019

Solderless terminals
ring-type
A.W.G. 8 (10 mm²) M 8

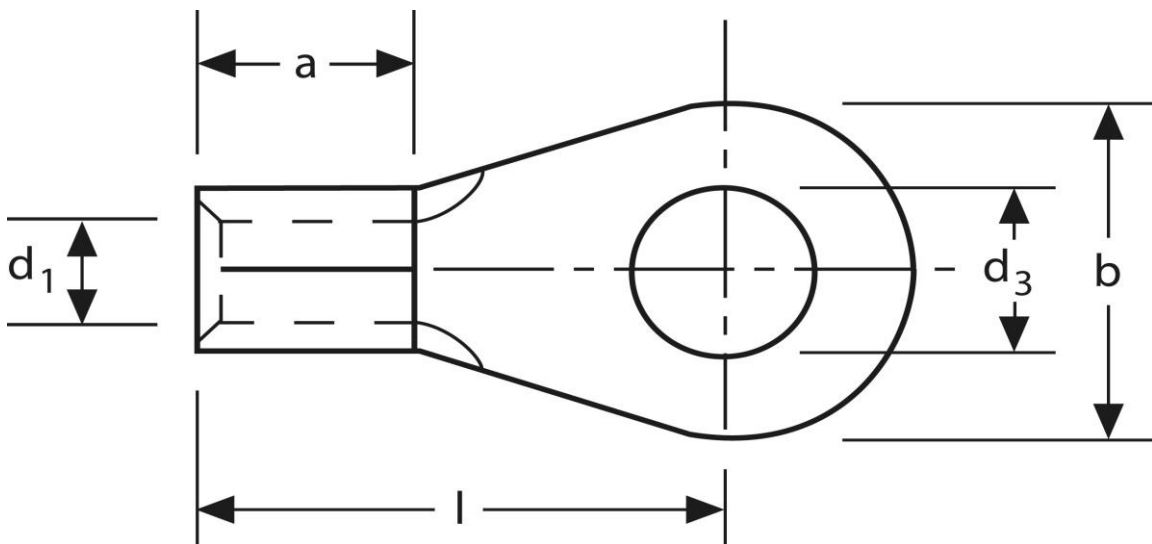

part no.	material	surface		
K 304080.2	E-CU	tin-plated	2,90 / 1000	500
	d₃	d₁	b	
in mm:	8,4	4,5	15	
	l	a	s	
in mm:	22,3	8,5	1,2	

date: 24.01.2019