

Quetschkabelschuhe

Ringform
10 mm² M 8

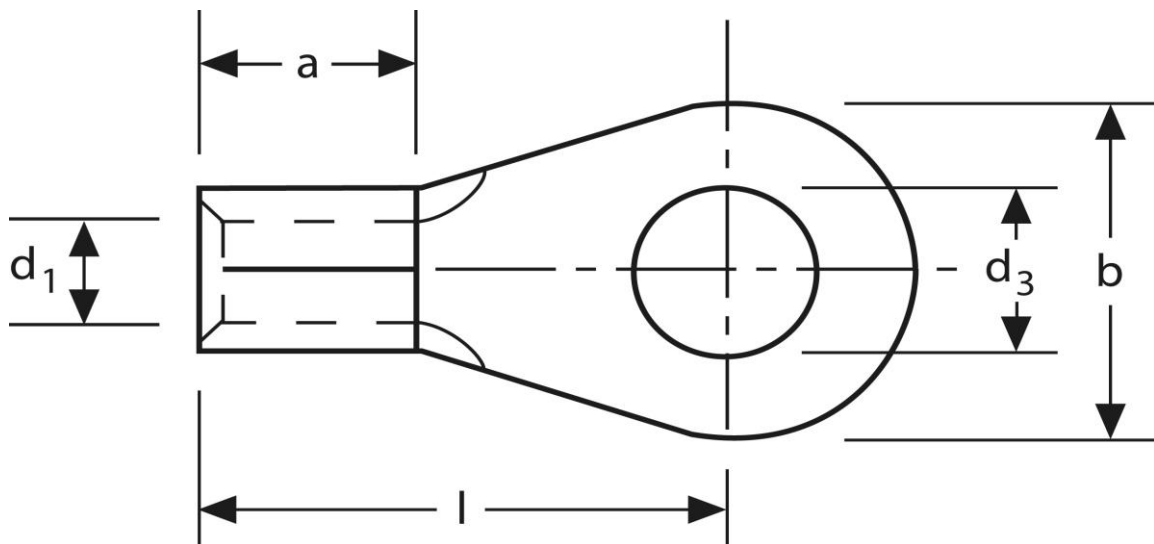

Art.Nr.	Werkstoff	Oberfläche		
K 304080.1	E-CU	galv. Sn	2,90 / 1000	500
	d ₃	d ₁	b	
in mm:	8,4	4,5	14	
	l	a	s	
in mm:	20	8	1,1	

Stand: 25.01.2019

Solderless terminals
ring-type
10 mm² M 8

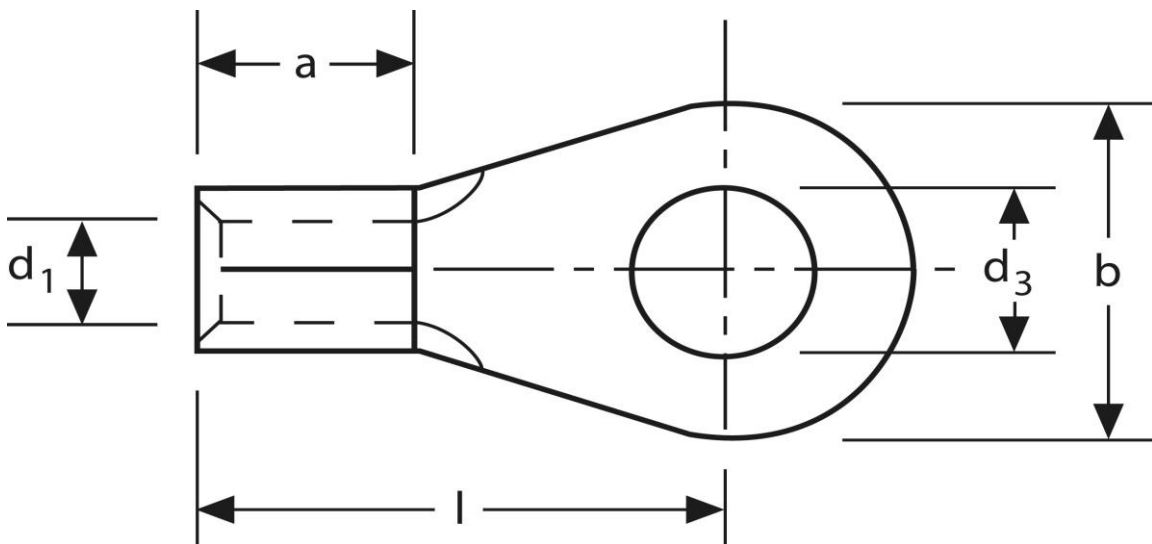

part no.	material	surface		
K 304080.1	E-CU	tin-plated	2,90 / 1000	500
	d₃	d₁	b	
in mm:	8,4	4,5	14	
	l	a	s	
in mm:	20	8	1,1	

date: 25.01.2019