

Quetschkabelschuhe

Ringform
10 mm² M 5

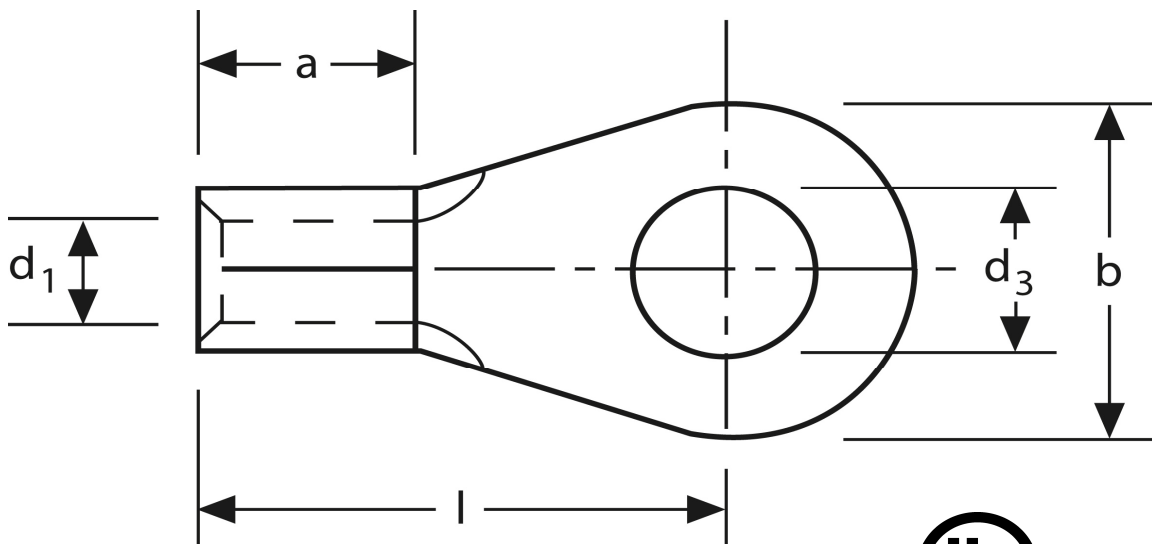

Art.Nr.	Werkstoff	Oberfläche		
K 304050	E-CU	galv. Sn	2,25 / 1000	500
	d₃	d₁	b	
in mm:	5,3	4,5	10	
	l	a	s	
in mm:	16	8	1,1	

Stand: 08.07.2014

Solderless terminals
ring-type
10 mm² M 5

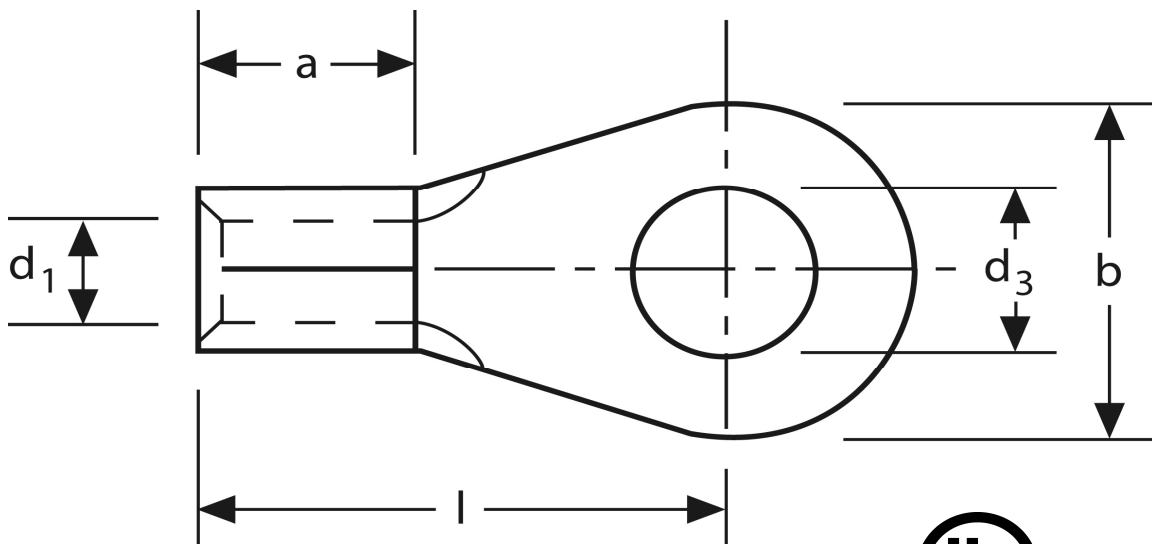

part no.	material	surface		
K 304050	E-CU	tin-plated	2,25 / 1000	500
	d₃	d₁	b	
in mm:	5,3	4,5	10	
	l	a	s	
in mm:	16	8	1,1	

date: 08.07.2014