

Quetschkabelschuhe

Ringform
6 mm² M 8

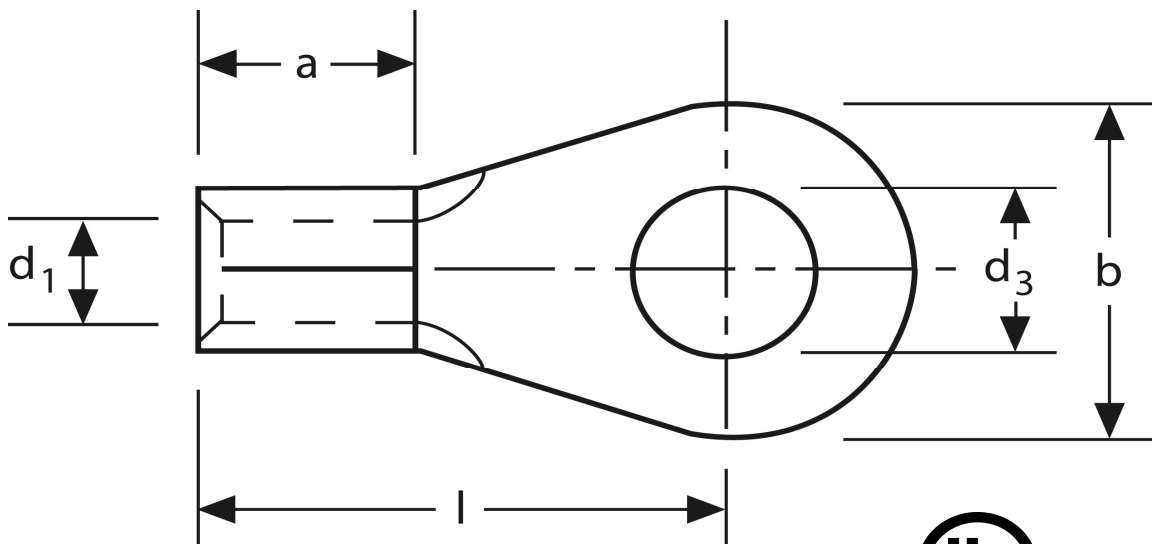

Art.Nr.	Werkstoff	Oberfläche		
K 303080	E-CU	galv. Sn	2,20 / 1000	1.000
	d₃	d₁	b	
in mm:	8,4	3,6	14	
	l	a	s	
in mm:	19	6	1,0	

Stand: 08.07.2014

Solderless terminals
ring-type
6 mm² M 8

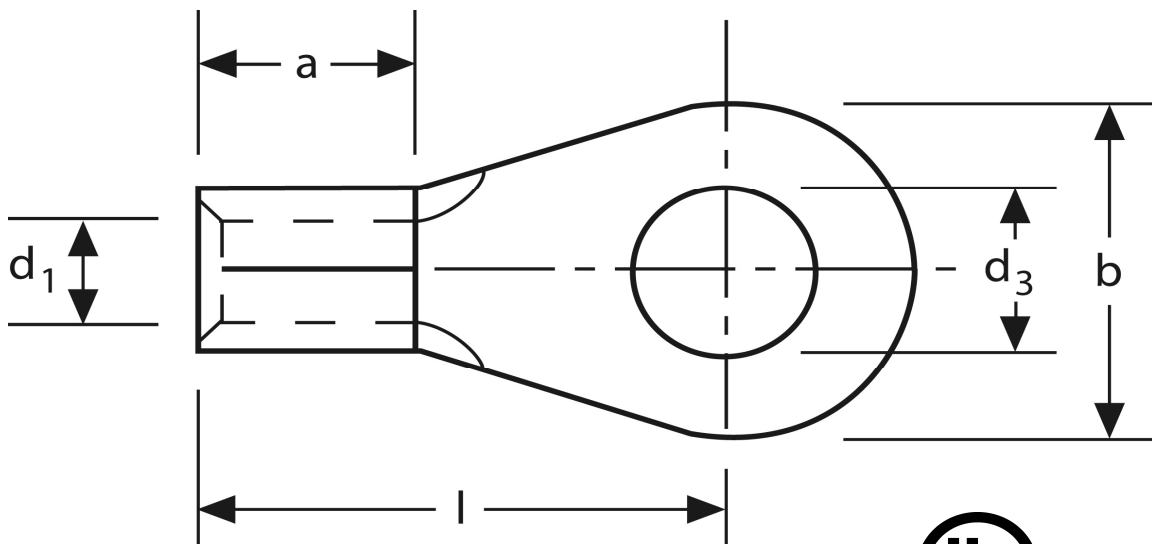

part no.	material	surface		
K 303080	E-CU	tin-plated	2,20 / 1000	1.000
	d₃	d₁	b	
in mm:	8,4	3,6	14	
	l	a	s	
in mm:	19	6	1,0	

date: 08.07.2014