

Quetschkabelschuhe

Ringform, Fe-Zn beschichtet, schwarz Cr VI frei

6 mm² M5

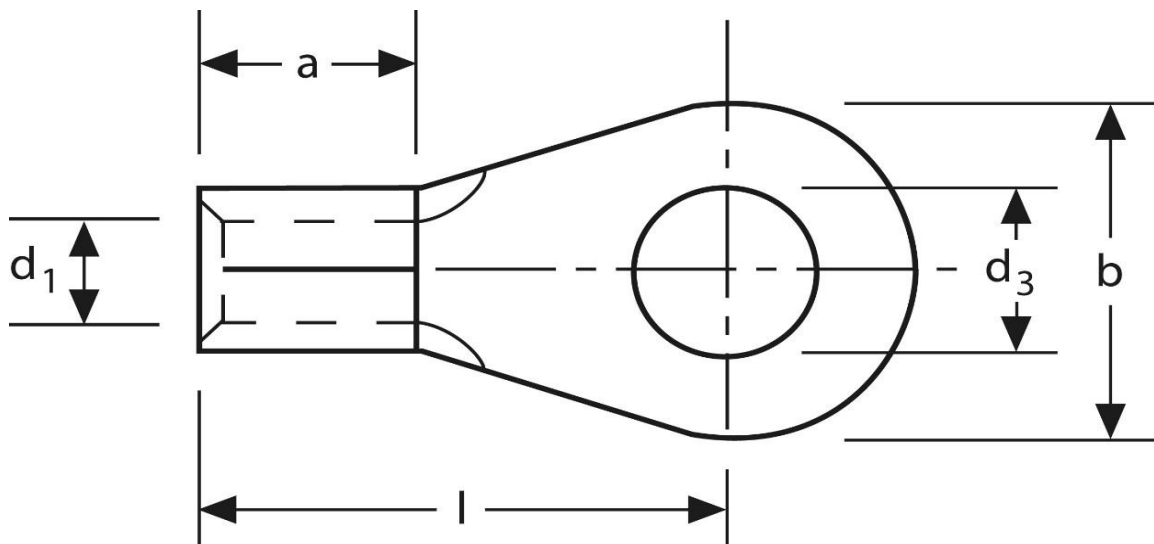

Art.Nr.	Werkstoff	Oberfläche		
K303050FeZn	E-CU	Fe/Zn schw.	1,60 / 1000	1.000
	d ₃	d ₁	b	
in mm:	5,3	3,6	10	
	l	a	s	
in mm:	15	6	1,0	

Stand: 23.01.2019

Solderless terminals
ring-type, Fe-Zn coated, black Cr VI free
6 mm² M5

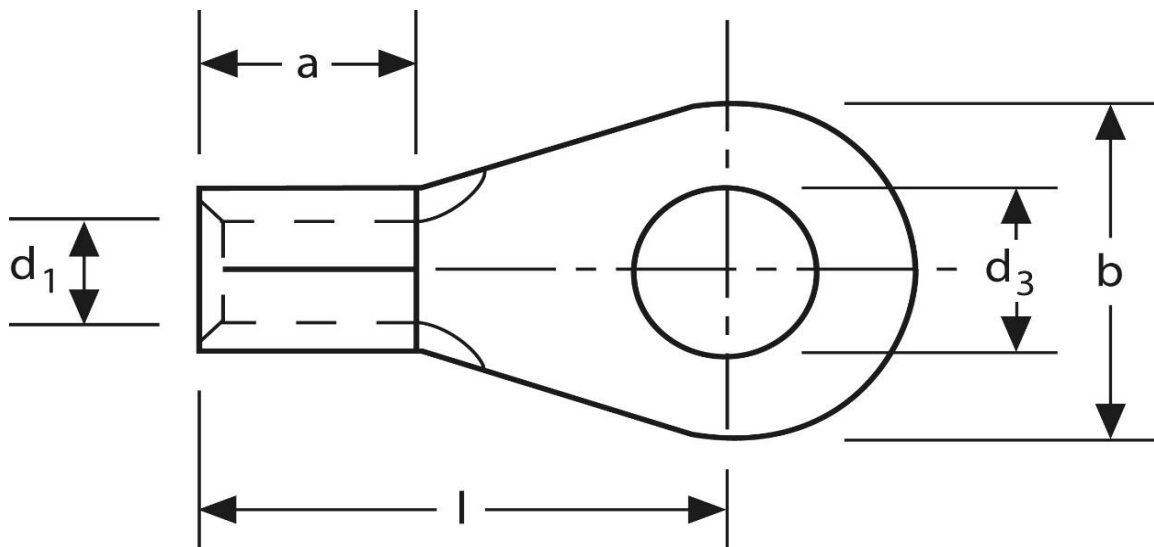

part no.	material	surface		
K303050FeZn	E-CU	Fe/Zn black	1,60 / 1000	1.000
	d₃	d₁	b	
in mm:	5,3	3,6	10	
	l	a	s	
in mm:	15	6	1,0	

date: 23.01.2019