

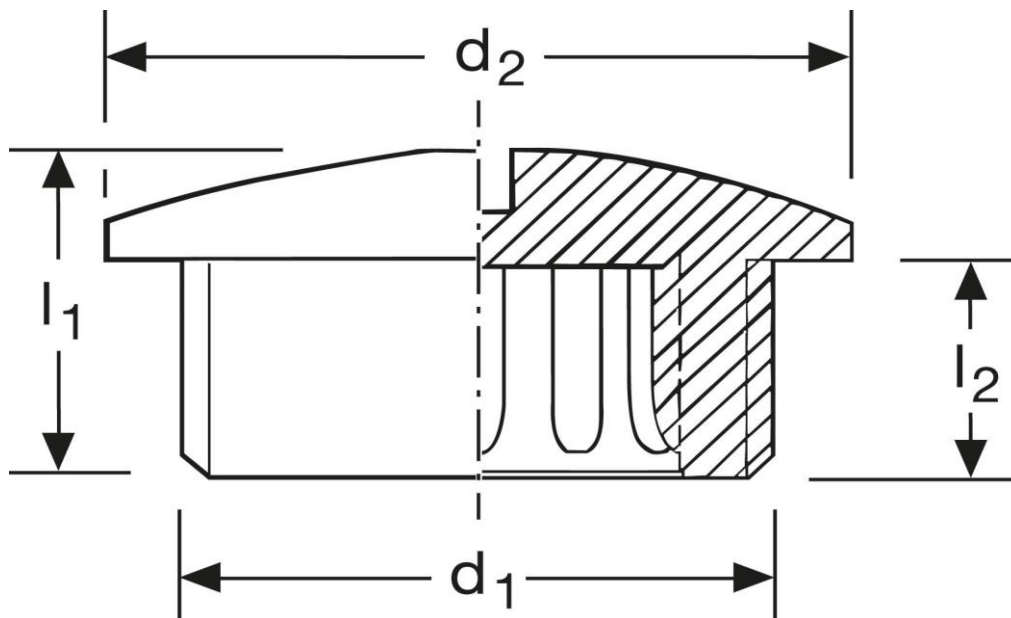

Verschlusschrauben G72
metrisches Anschlussgewinde
M 16 x 1,5



Art. Nr.	Material	Nenngröße	
G872016.1	PA glasfaserverstärkt	M 16 x 1,5	100
	d_1	d_2	l_1
in mm:	16	20	10,5
			l_2
			6
	Farbe	Temperaturbereich	Schutzart
	grau - RAL 7035	- 30°C bis + 100°C	IP 54

Stand: 05.08.2016

Locking plugs with flange G72
 metric thread
 M 16 x 1,5

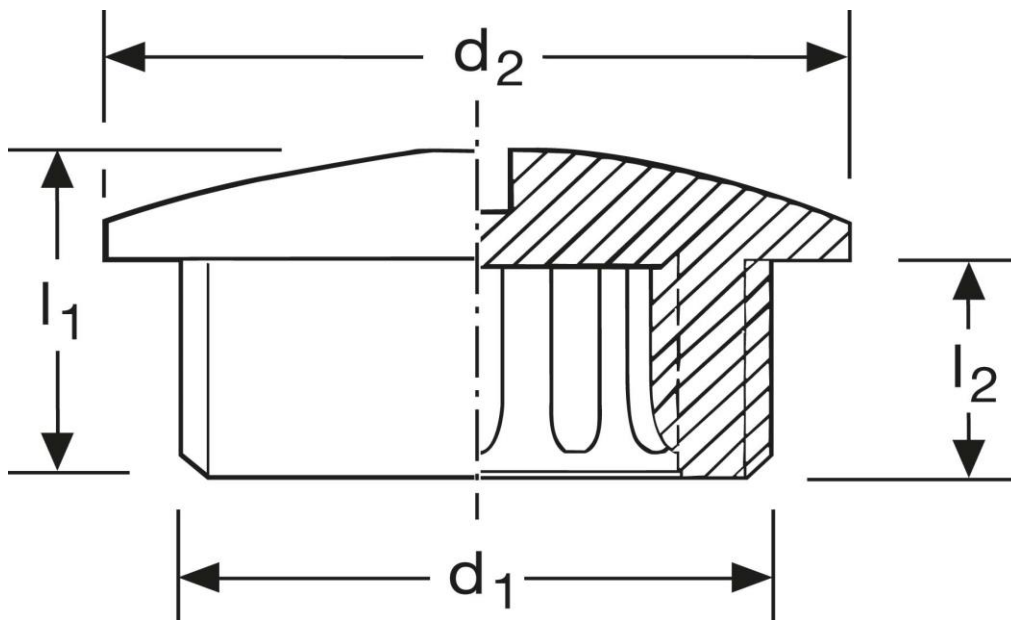

part no.	material	nom. size	
G872016.1	PA glass fibre reinforced	M 16 x 1,5	100
	l_1	l_2	d_1
in mm:	16	20	6
	d_1		
colour	temperature range	prot. class	
grey - RAL 7035	- 30°C up to + 100°C	IP 54	

date: 05.08.2016