

Kabelbinder Pan-Steel

AISI 316, beschichtet

521 - 7,9 mm

grün

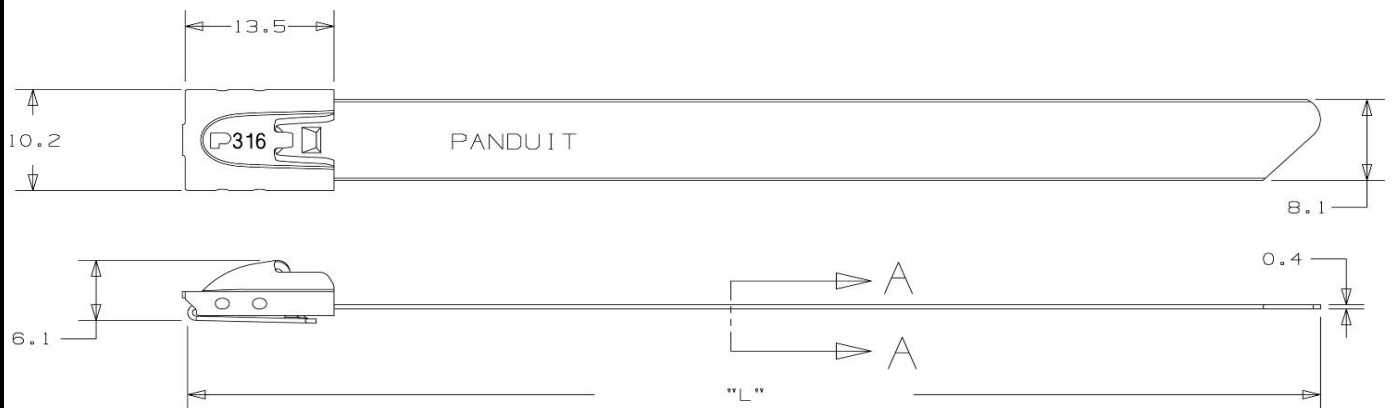

Art.Nr.	Werkstoff	Beschichtung
PA-MLTFC6H-LP316GR	Edelstahl AISI 316	Polyester, grün
	L	Kabelbaum max.
in mm:	521	152
	Temperaturbereich	Zugfestigkeit
	-40°C bis + 150°C	min. 1112 N

Stand: 02.01.2017