

Rundsteckhülsen

vollisoliert

1,5 - 2,5 mm²

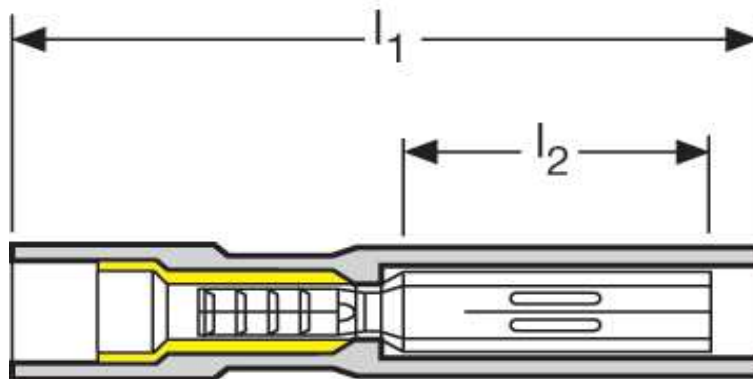

Katalogseite: 3.13

Art.Nr.	Werkstoff	Isolation		
K 4231020 N	Ms+E-Cu gal. Sn	PA	1,27/1000	1.000
	l1	l2	s	Ø Stecker
in mm:	24,5	14,0	0,40	4