

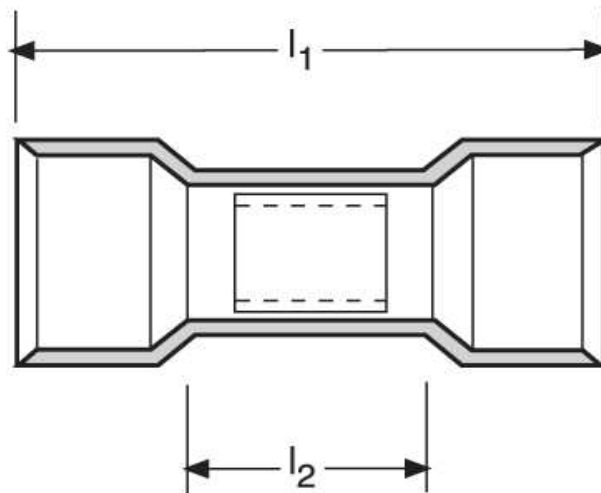

Parallelverbinder

2,5 - 6,0 mm²



Katalogseite: 3.10

Art.Nr.	Werkstoff	Isolation		
K413060N	E-Cu gal. Sn	PA	1,40/1000	1.000
	l1	l2	s	
in mm:	21,0	9,0	1,0	