

Quetschkabelschuhe

Gabelform
0,5 - 1,5 mm²

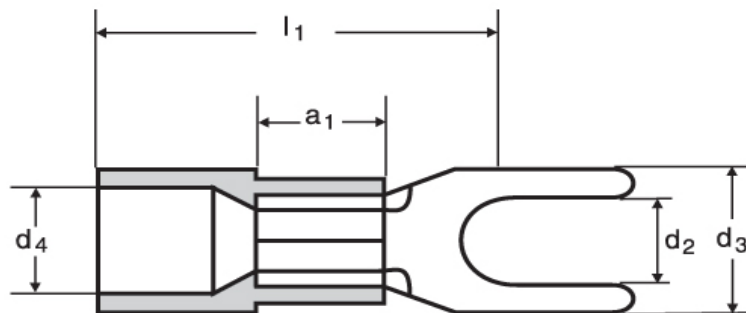

N



D

Katalogseite: 3.04

Art.Nr.	Werkstoff	Isolation		
K404040N	E-Cu gal. Sn	PA	0,650/1000	1.000
	d2	d3	d4	
in mm:	4,3	6,4	4,1	
	l1	a1	s	
in mm:	17,0	5,0	0,8	