

Quetschkabelschuhe

Gabelform

0,1 - 0,5 mm²

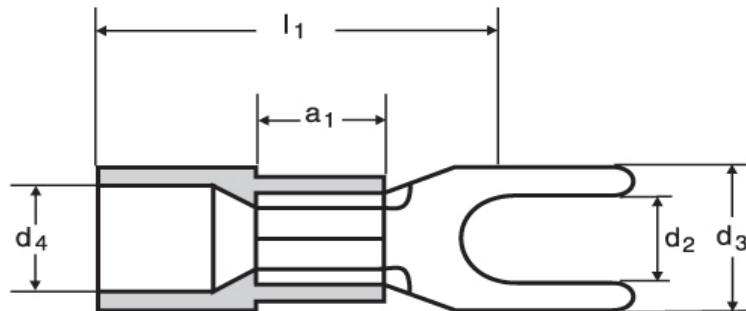

N



D

Katalogseite: 3.04

Art.Nr.	Werkstoff	Isolation		
K403920D	E-Cu gal. Sn	PA	0,20/1000	1.000
	d2	d3	d4	
in mm:	2,2	5,0	3,2	
	l1	a1	s	
in mm:	16,0	5,0	0,5	