

Kleinkabelschuh vernickelt
Ringform, mit Sichtloch
2,5 mm² M6

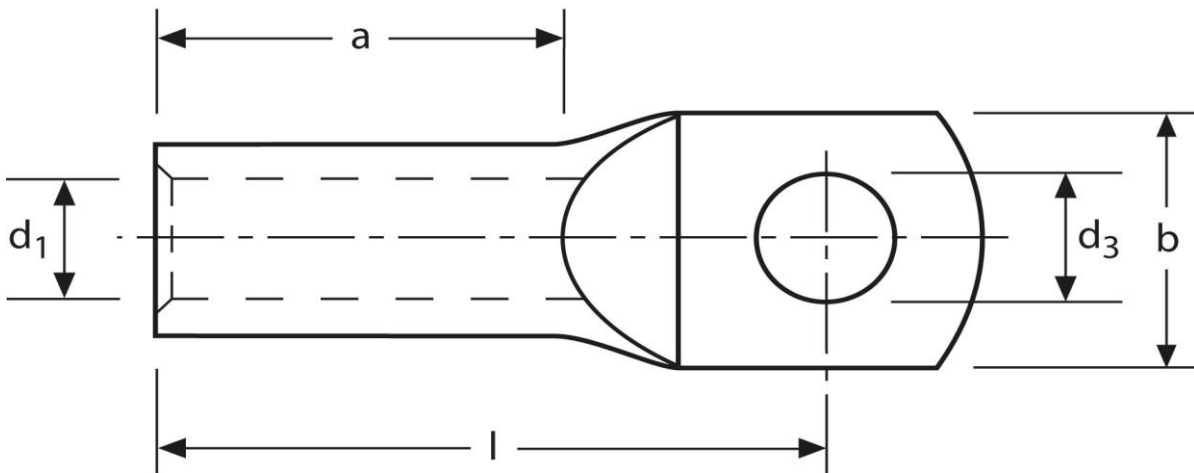

Art.Nr.	Werkstoff	Oberfläche		
K377060vn	E-CU	vernickelt	1,5 / 1000	100
	d ₃	d ₁	b	
in mm:	6,5	2,3	9,5	
	l	a		
in mm:	16	6		

Stand: 09.08.2016

Mini cable-lugs nickel plated
ring-type, with inspection hole
2,5 mm² M6

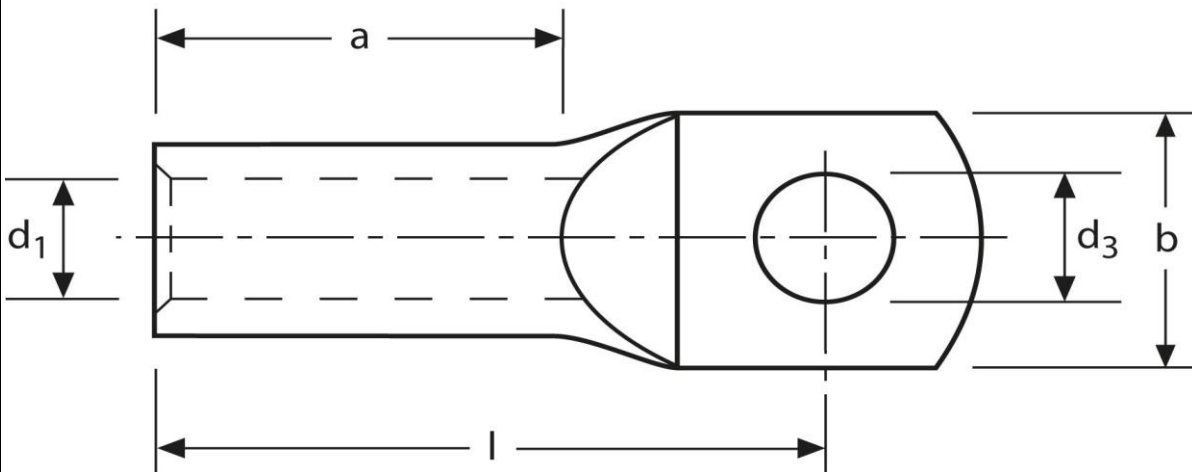

part no.	material	surface		
K377060vn	E-CU	nickel	1,5 / 1000	100
	d₃	d₁	b	
in mm:	6,5	2,3	9,5	
	l	a		
in mm:	16	6		

date: 09.08.2016