

Kleinkabelschuh
Ringform, mit Sichtloch
2,5 mm² M3

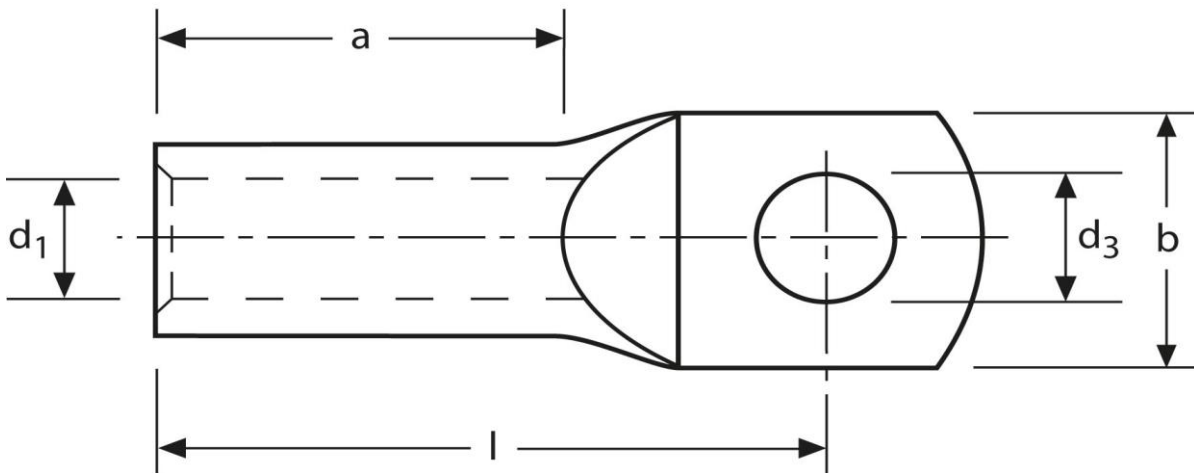

Art.Nr.	Werkstoff	Oberfläche		
K377030	E-CU	galv. Sn	1,47 / 1000	100
	d ₃	d ₁	b	
in mm:	3,2	2,3	7,5	
	l	a		
in mm:	13	6		

Stand: 17.10.2016

Mini cable-lugs
ring-type, with inspection hole
2,5 mm² M3

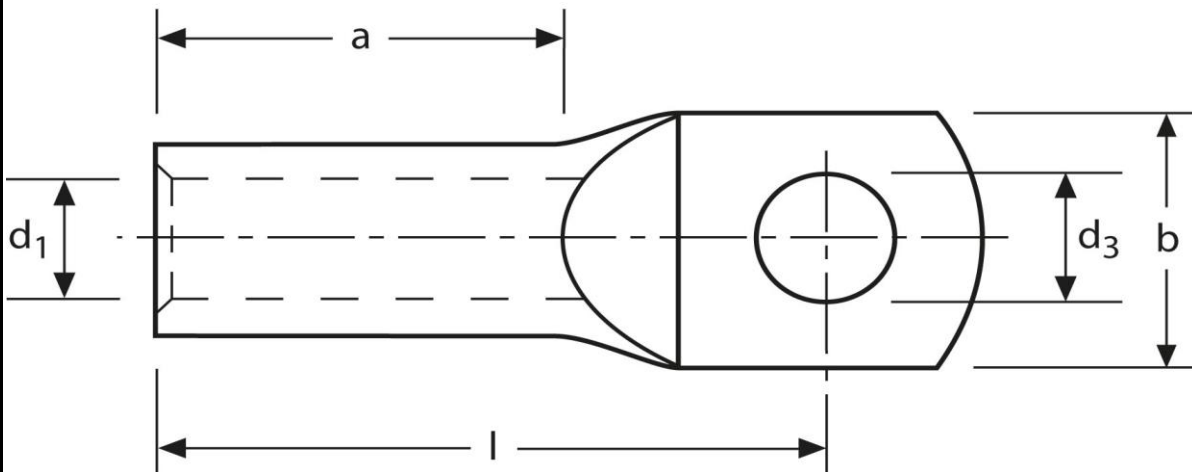

part no.	material	surface		
K377030	E-CU	tin-plated	1,47 / 1000	100
	d₃	d₁	b	
in mm:	3,2	2,3	7,5	
	l	a		
in mm:	13	6		

date: 17.10.2016