

Rohrkabelschuhe

Edelstahl V2A
 0,5 - 1 mm² M4

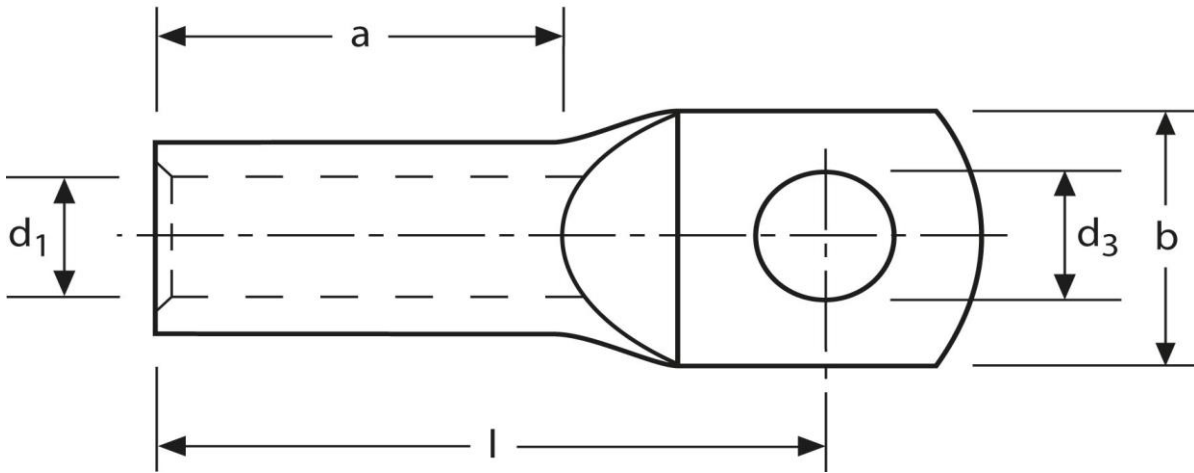

Art.Nr.	Werkstoff	Typ		
K376040St	Edelstahl	V2A	0,8 / 1000	100
	d₃	d₁	b	l
in mm:	4,3	1,6	6,5	13
	a	Temperaturbeständigkeit		
	6 mm	bis 400°C		

Stand: 23.07.2018

Tubular cable-lugs
stainless steel V2A
0,5 - 1 mm² M4

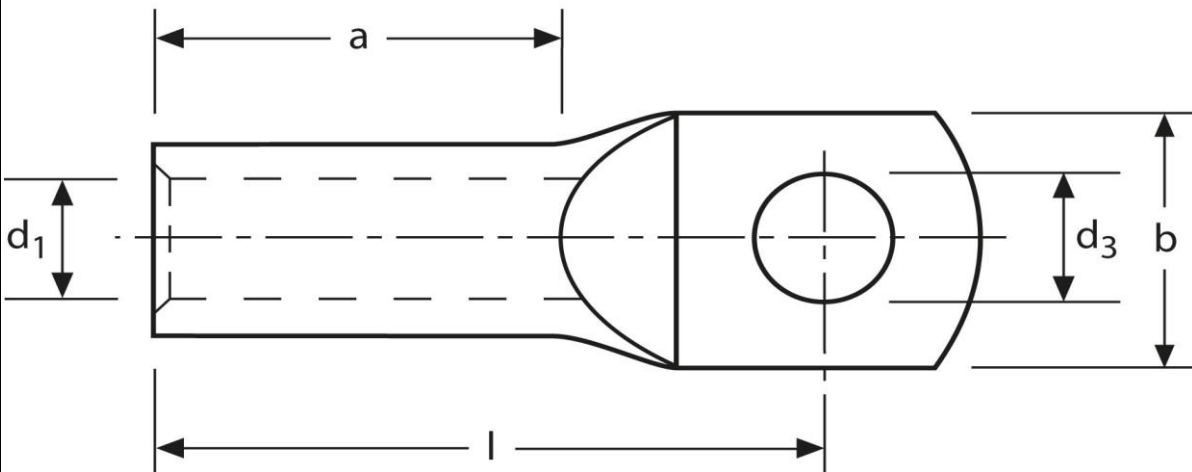

part no.	material	type		
K376040St	stainl. steel	V2A	0,8 / 1000	100
	d ₃	d ₁	b	l
in mm:	4,3	1,6	6,5	13
	a	temperature resistance		
	6 mm	up to 400°C		

date: 23.07.2018