

Rohrkabelschuhe

handelsüblich

16 mm² M6

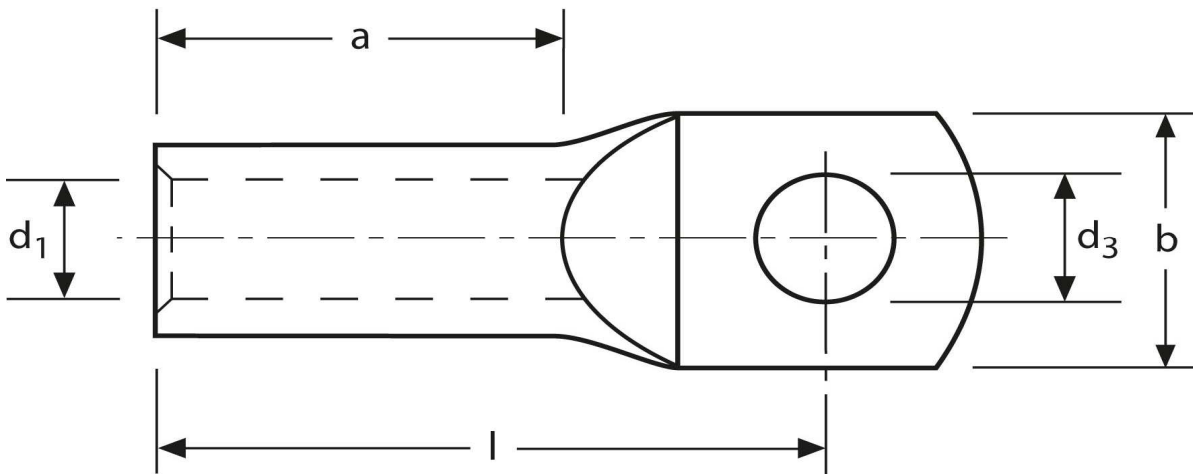

Art.Nr.	Werkstoff	Oberfläche		
K337060	E-CU	galv. Sn	9,0/ 1000	100
	d₃	d₁	b	
in mm:	6,5	5,5	12,0	
	l	a		
in mm:	25,6	13		

Stand: 09.10.2014

Tubular cable-lugs
 commercial
 16 mm² M6

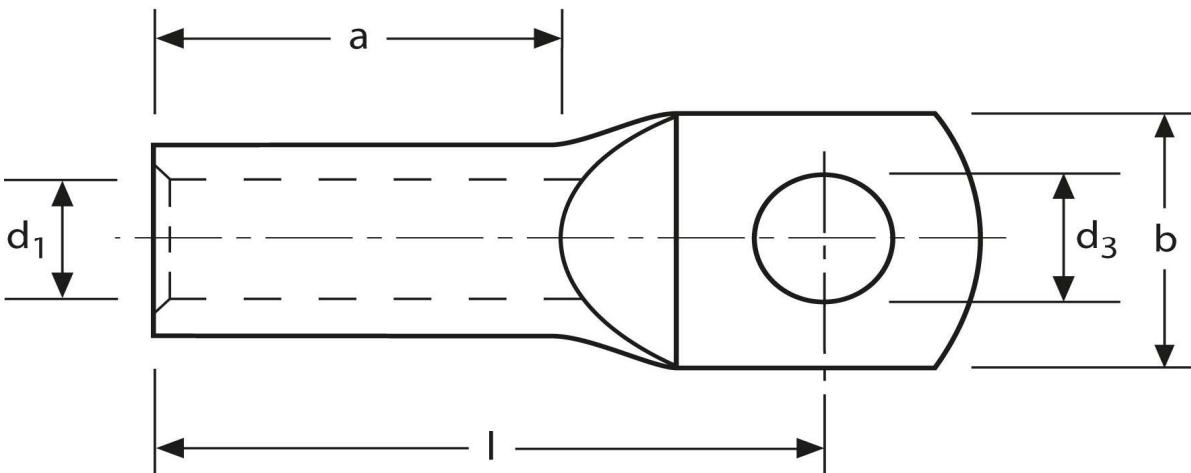

part no.	material	surface		
K337060	E-CU	tin-plated	9,0/ 1000	100
	d₃	d₁	b	
in mm:	6,5	5,5	12,0	
	l	a		
in mm:	25,6	13		

date: 09.10.2014