

Lötkaabelschuh
Ringform
1,5 mm² M 4

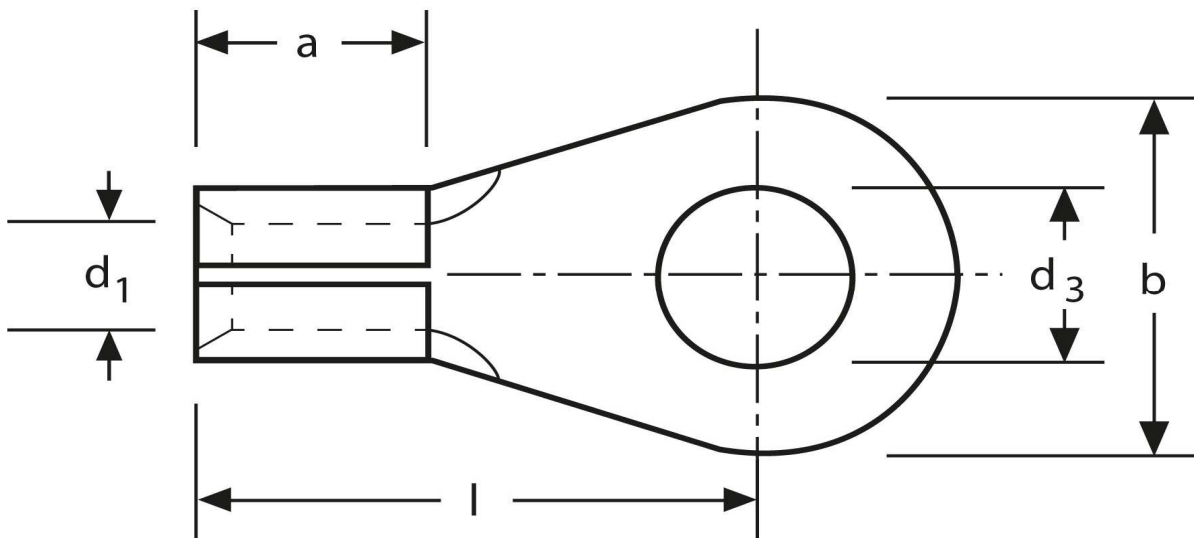

Artikel Nr.	Werkstoff	Oberfläche		
K 3101040	Messing	galv. Sn	0,40 / 1000	1.000
	d₃	d₁	b	
in mm:	4,3	1,4	8	
	l	a	Nenngröße	
in mm:	11,5	3,5	4 - 1,4	

Stand: 14.07.2014

Solder tags
 ring type
 1,5 mm² M 4

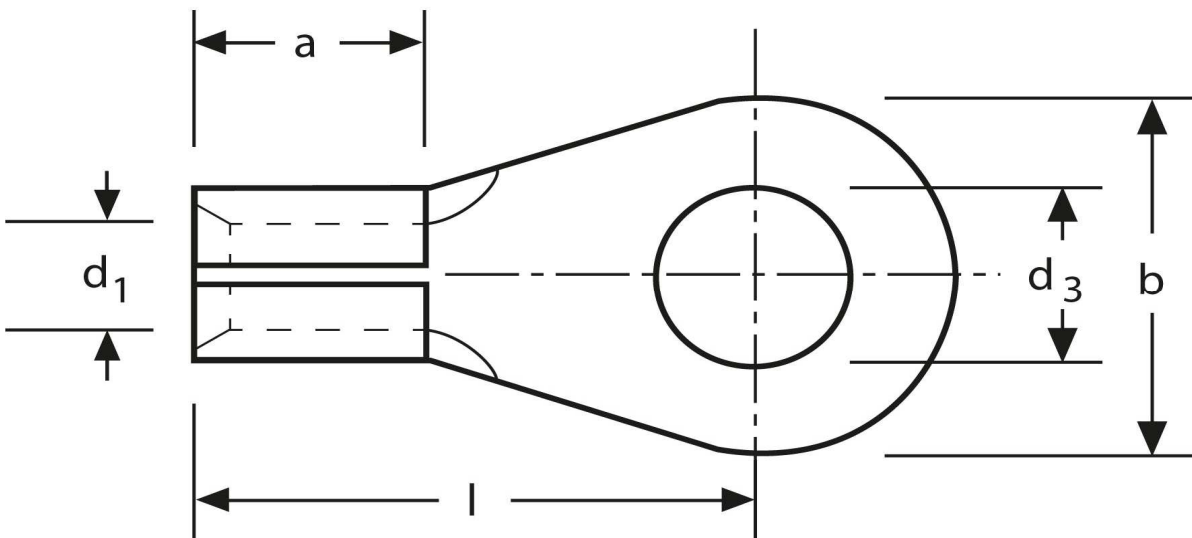

part no.	material	surface		
K 3101040	brass	tin-plated	0,40 / 1000	1.000
	d₃	d₁	b	
in mm:	4,3	1,4	8	
	l	a	nominal size	
in mm:	11,5	3,5	4 - 1,4	

date: 14.07.2014