

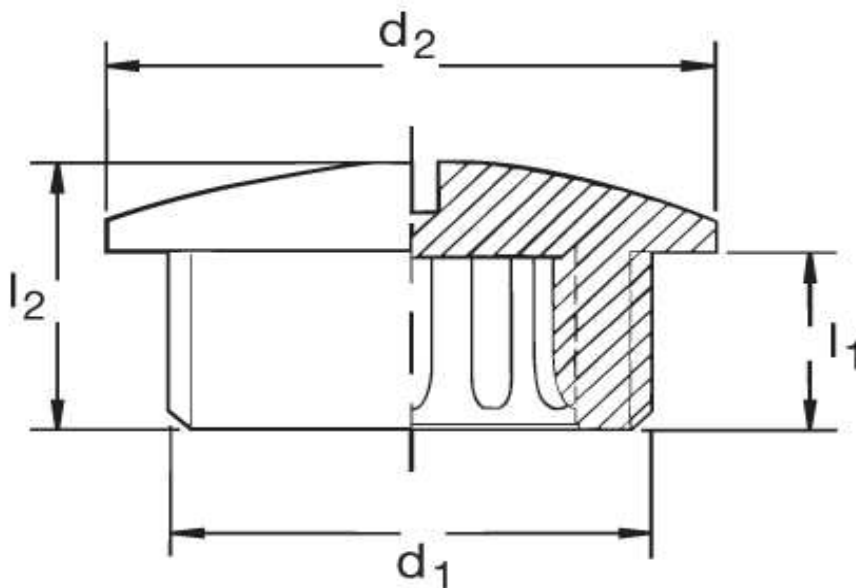



**Verschlusschraube GM 72**

DIN 46320 und EN 60423



Katalogseite: 9.13

Art.Nr.	Werkstoff		Nenngröße	
GM 872210	Mess. Vern.	100	PG 21	
	d1	d2	l2	l1
in mm:	28,3	30,0	11,00	7,00