

**Druckschraube GM 71
PG 36**

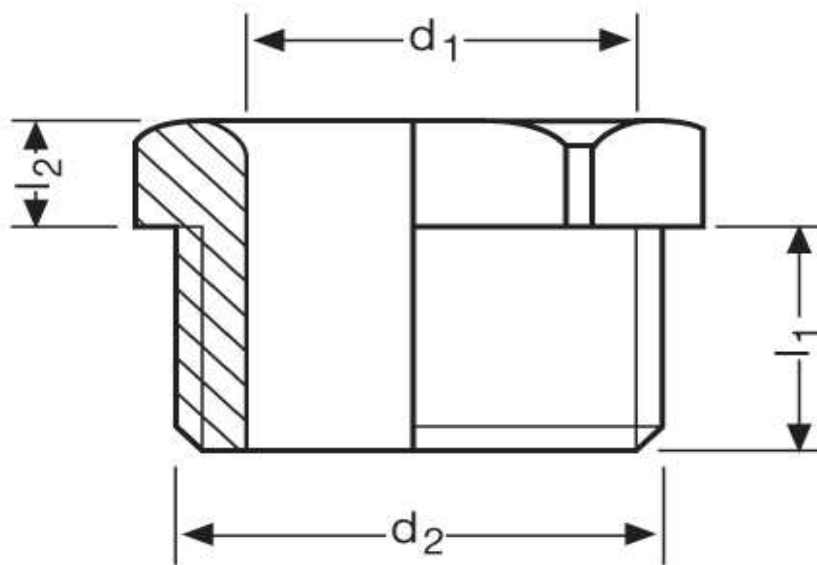

Katalogseite: 9.13

Art.Nr.	Werkstoff	
GM 871360	Mess. Vern.	50

	d1	d2	l2	
in mm:	34,0	14,0	9,50	47,00