

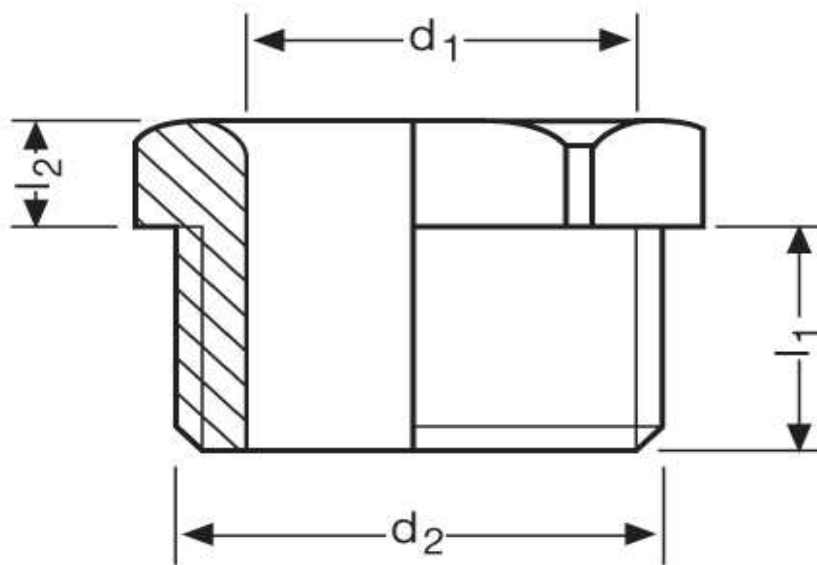

**Druckschraube GM 71
PG 9**



Katalogseite: 9.13

Art.Nr.	Werkstoff	
GM 872090	Mess. Vern.	100

	d1	d2	l2	
in mm:	9,5	8,5	6,00	15,00