

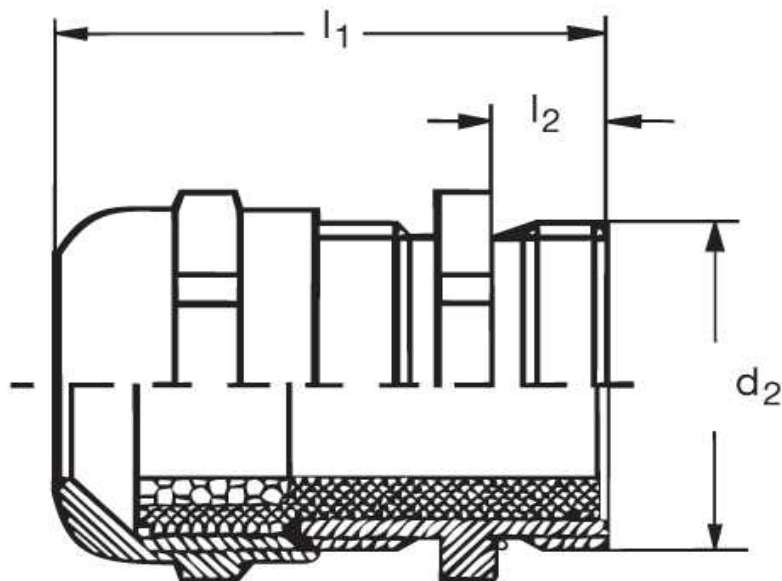

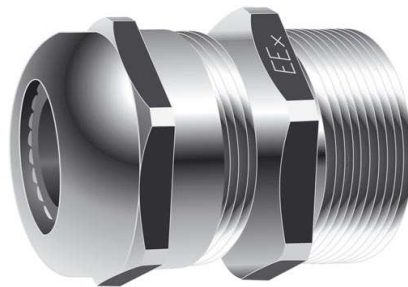

**Eisenacher**  
elektroTECHNIK GmbH

**Kabel-Anschluss- und Verbindungstechnik**

**Kabelverschraubung  
GM 40 Eex e II**



Katalogseite: 9.08

Art.Nr.	Werkstoff	Nenngröße		Kabel Ø
GM 840211	Mess. vern.	PG 21 L	25	13 - 18
	d1	l1	l2	
in mm:	28,3	12,0	25,00	