

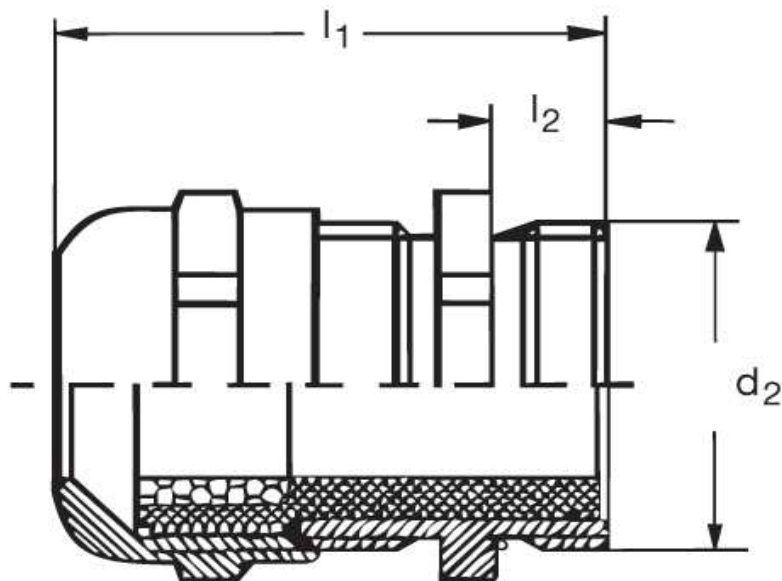

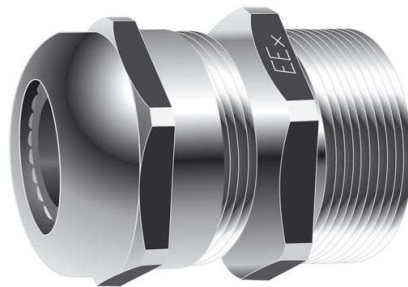

**Eisenacher**  
elektroTECHNIK GmbH

**Kabel-Anschluss- und Verbindungstechnik**

**Kabelverschraubung  
GM 40 Eex e II**



Katalogseite: 9.08

Art.Nr.	Werkstoff	Nenngröße		Kabel Ø
GM 840111	Mess. vern.	PG 11 L	50	5 - 10
	d1	l1	l2	
in mm:	18,6	10,0	21,00	