

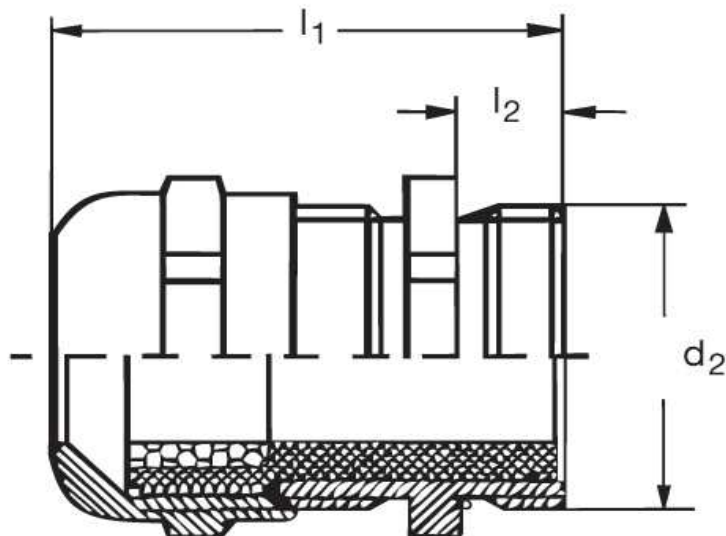

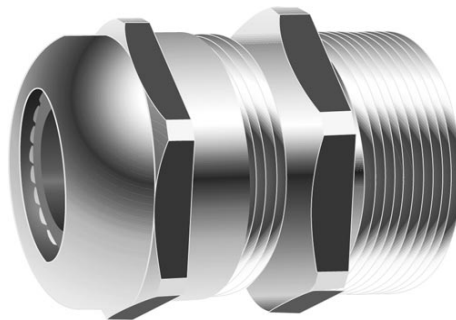

**Kabelverschraubung GM 20**



Katalogseite: 9.04

Art.Nr.	Werkstoff	Nenngröße		Kabel Ø
GM 820361	Mess. vern.	PG 36,0 L	10	22 - 32
	d1	l1	l2	
in mm:	47,0	15,0	35,00	