

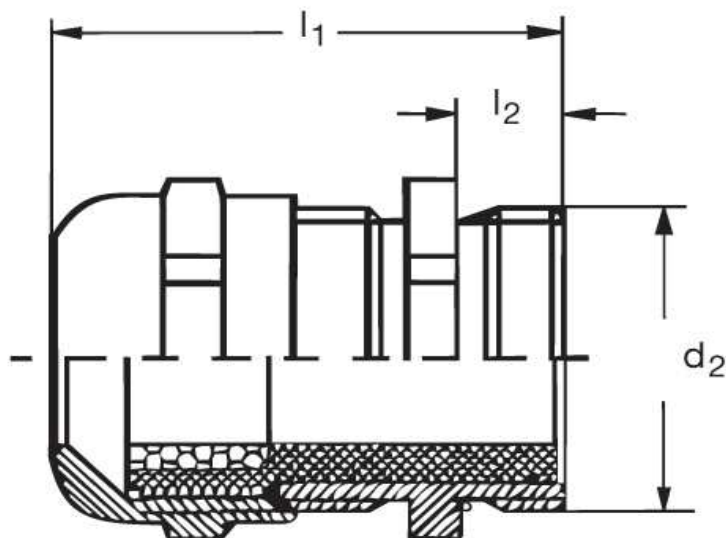

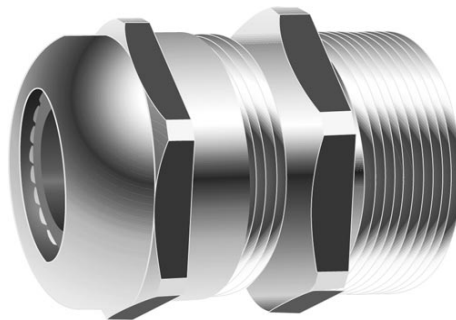

Kabelverschraubung GM 20



Katalogseite: 9.04

Art.Nr.	Werkstoff	Nenngröße		Kabel Ø
GM 820290	Mess. vern.	PG 29,0 N	20	18 - 25
	d1	l1	l2	
in mm:	37,0	8,0	29,00	