

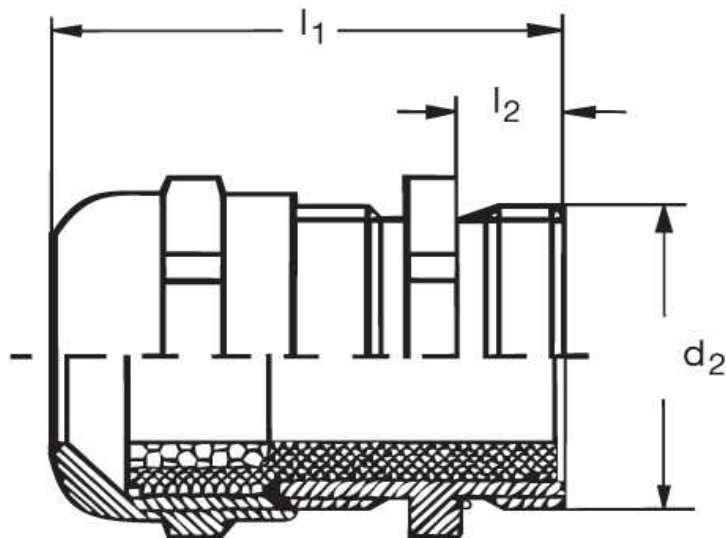

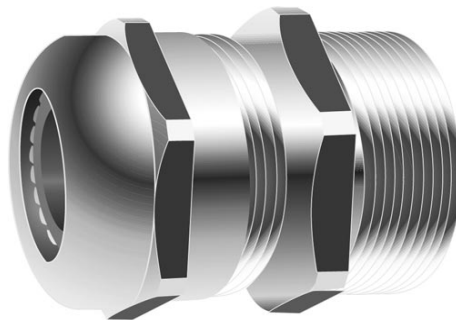

**Kabelverschraubung GM 20**



Katalogseite: 9.04

Art.Nr.	Werkstoff	Nenngröße		Kabel Ø
GM 820160	Mess. vern.	PG 16,0 N	50	10 - 14
	d1	l1	l2	
in mm:	22,5	6,5	23,00	