

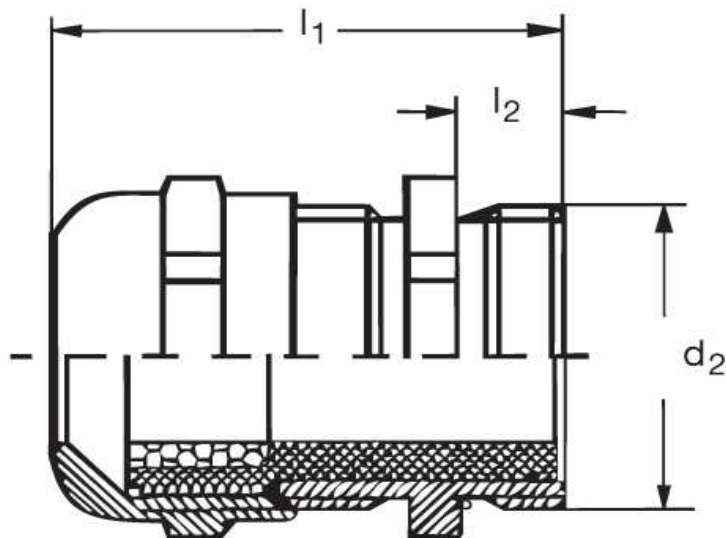

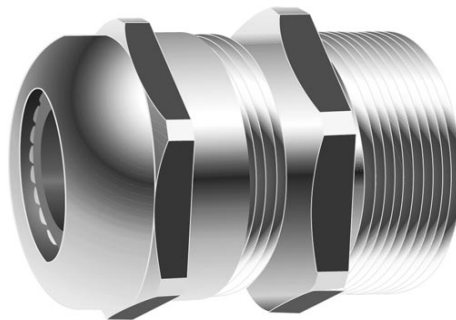

Kabelverschraubung GM 20



Katalogseite: 9.04

Art.Nr.	Werkstoff	Nenngröße		Kabel Ø
GM 820111	Mess. vern.	PG 11,0 L	50	5 - 10
	d1	l1	l2	
in mm:	18,6	15,0	21,00	