

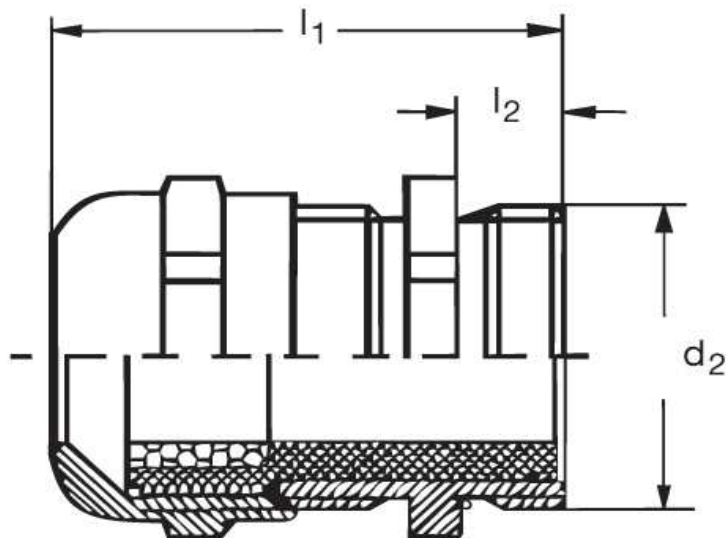

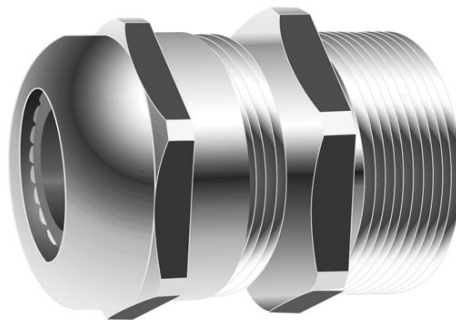

Kabelverschraubung GM 20



Katalogseite: 9.04

Art.Nr.	Werkstoff	Nenngröße		Kabel Ø
GM 820090	Mess. vern.	PG 9,0 N	50	4 - 8
	d1	l1	l2	
in mm:	15,2	6,0	20,00	