

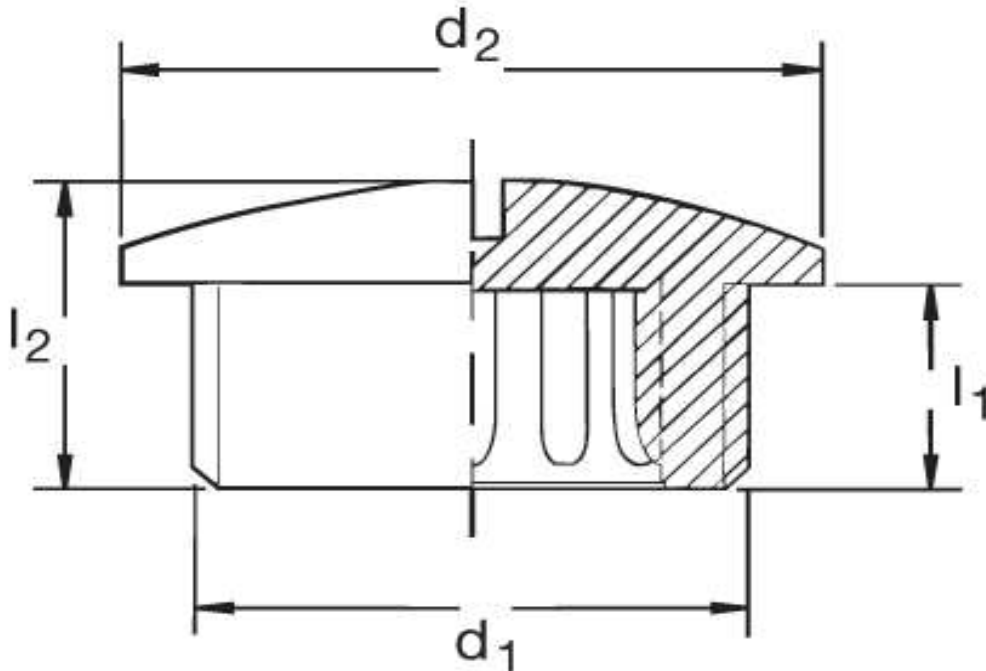

Verschlusschraube G 72
DIN 46320

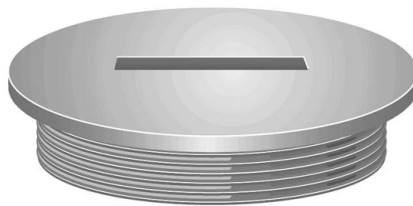

Katalogseite: 9.27

Art.Nr.	Farbe	Material	Nenngröße	
G 872420	grau	Polystyrol schlagfest	PG 42	25
G 872421	grau	Polyamid glasfaserverstärkt		
	d1	d2	l1	l2
in mm:	54,0	62,0	10,00	16