

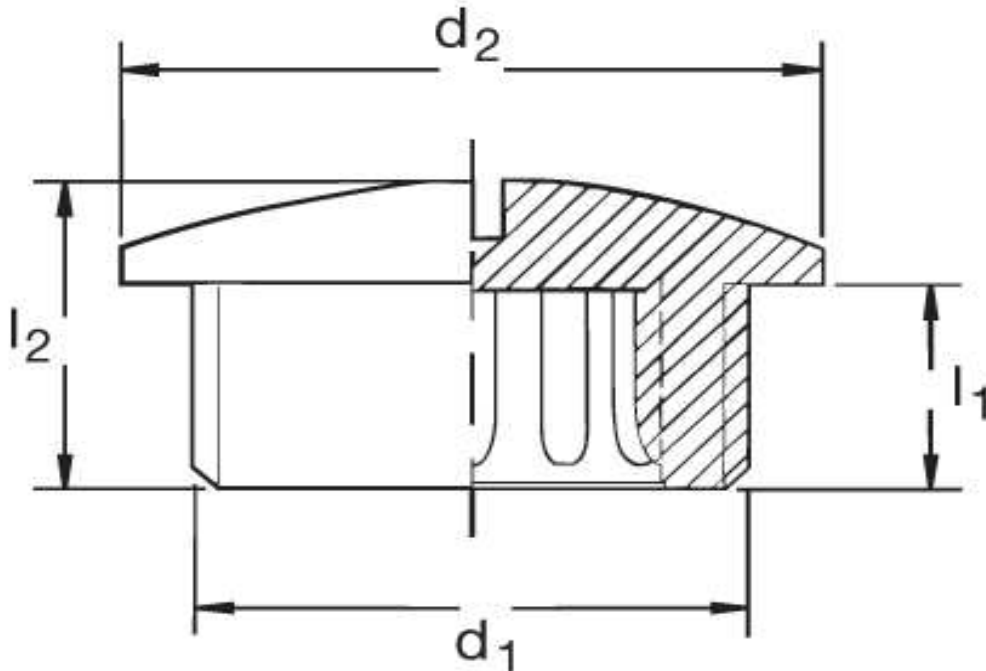

Verschlusschraube G 72
DIN 46320

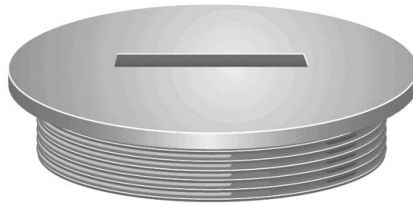

Katalogseite: 9.27

Art.Nr.	Farbe	Material	Nenngröße	
G 872110	grau	Polystyrol schlagfest	PG 11	100
G 872111	grau	Polyamid glasfaserverstärkt		
	d1	d2	l1	l2
in mm:	18,6	22,0	6,00	9