

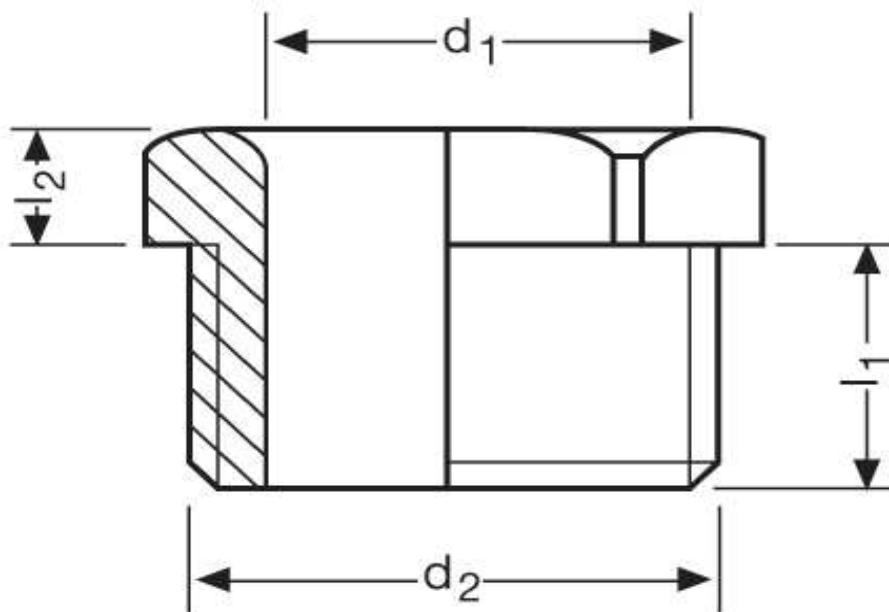

Druckschraube G 71 DIN 46320



Katalogseite: 9.26

Art.Nr.	Farbe	Material	Nenngröße		
G 871070	grau	Polystyrol schlagfest	PG 7	100	
G 871071	grau	Polyamid glasfaserverstärkt			
	d2	d1	l2	l1	
in mm:	12,5	6,5	8,50	13,5	13