

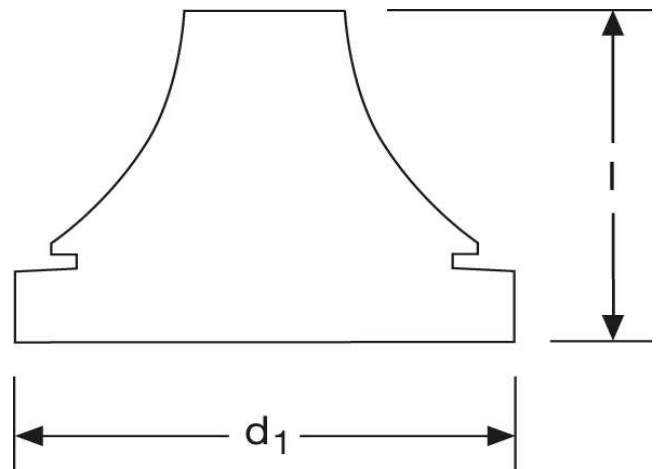

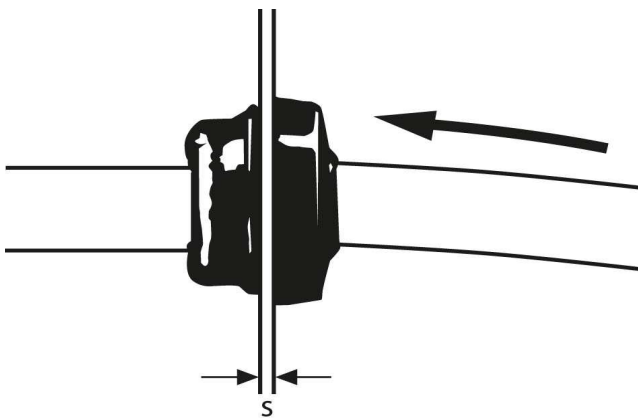

Kabeldurchführungen M 32



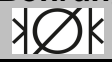

Art.Nr.	Werkstoff	Temperaturbereich			
G 8541421S	Chloroprenkautschuk	- 30°C bis + 100°C	25		
	Bohrung 	s	Kabel 	l	d₁
in mm:	32,5	1 - 4	15 - 20	24,6	38,5
Farbe	RAL 9005 schwarz				

Stand: 29.09.2014

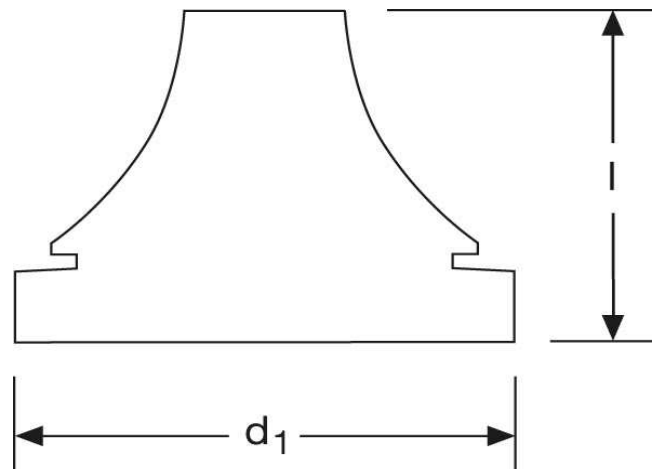
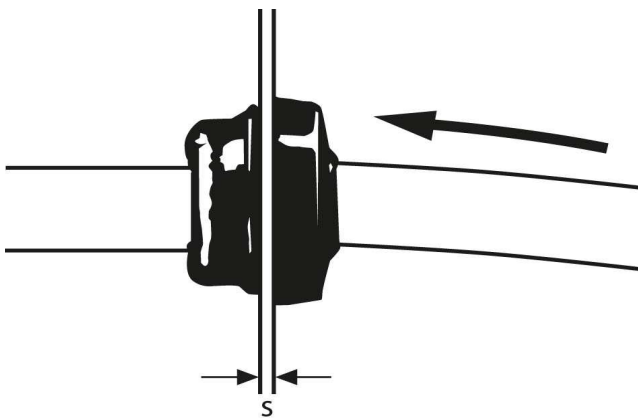
Sealing grommet M 32



part number	material	temperature range			
G 8541421S	Chloroprene rubber	- 30°C up to + 100°C	25		
	borehole	s	cable	l	d₁
					
in mm:	32,5	1 - 4	15 - 20	24,6	38,5
colour	RAL 9005 black				

date 29.09.2014