

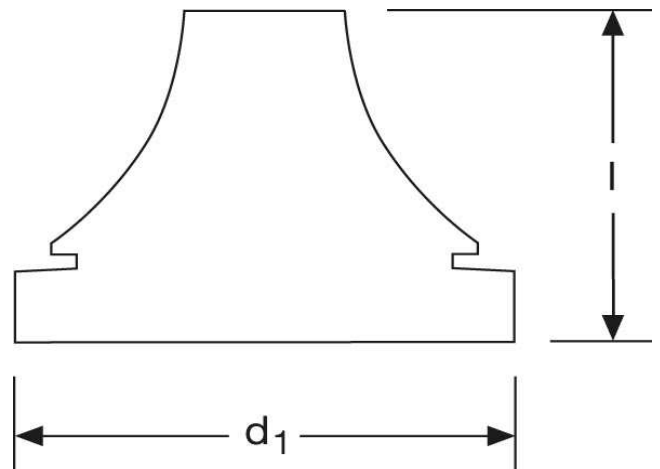

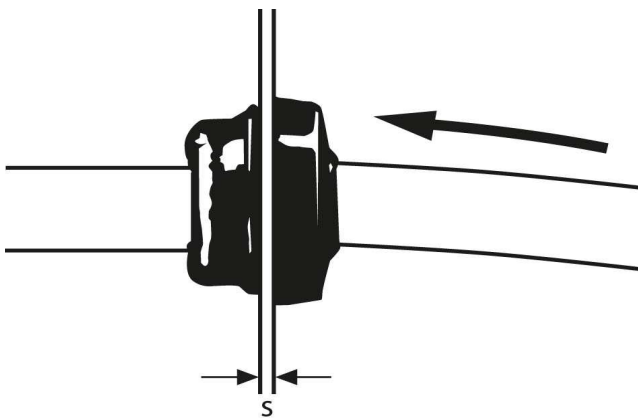

Kabeldurchführungen M 20



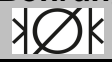

Art.Nr.	Werkstoff	Temperaturbereich			
G 8540711S	Chloroprenkautschuk	- 30°C bis + 100°C	50		
	Bohrung 	s	Kabel 	l	d₁
in mm:	20,5	1 - 4	8 - 13	20,0	25,5
Farbe	RAL 9005 schwarz				

Stand: 29.09.2014

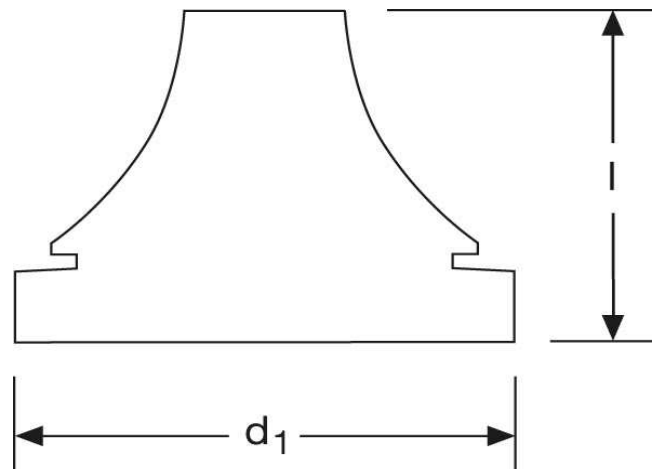
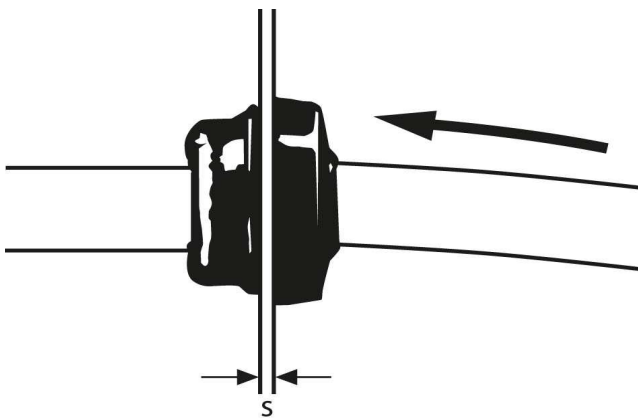
Sealing grommet M 20



part number	material	temperature range			
G 8540711S	Chloroprene rubber	- 30°C up to + 100°C	50		
	borehole	s	cable	l	d₁
					
in mm:	20,5	1 - 4	8 - 13	20,0	25,5
colour	RAL 9005 black				

date 29.09.2014