

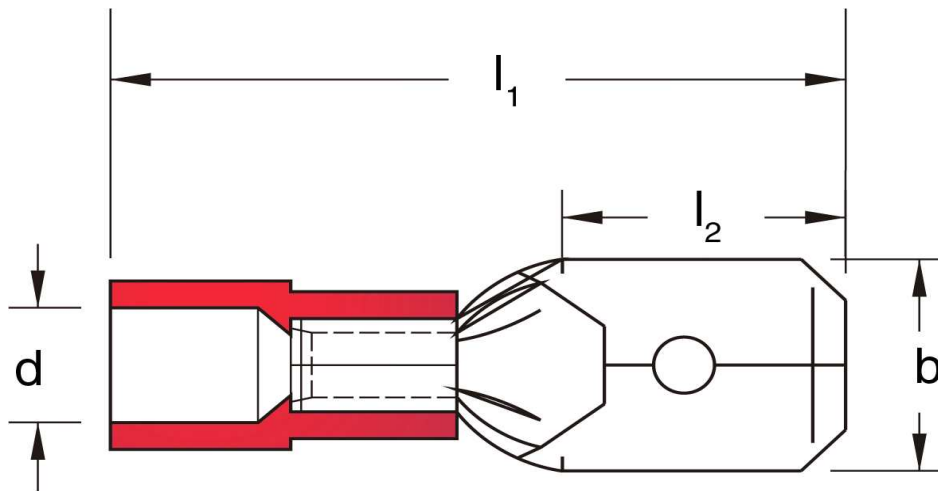

Flachstecker

22 - 16 A.W.G. (~ 0,5 - 1,5mm²)

rot

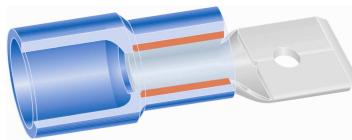

Katalogseite: 3.18

Art.Nr.	Werkstoff	Isolation		
F 615638 I	Ms,E-Cu, gal Sn	Nylon	0,95/1000	1.000
	l_1	l_2	d	b
in mm:	22,0	7,5	4,1	6,4
	s	Steckgröße		
in mm:	0,40	6,3 - 0,8		