

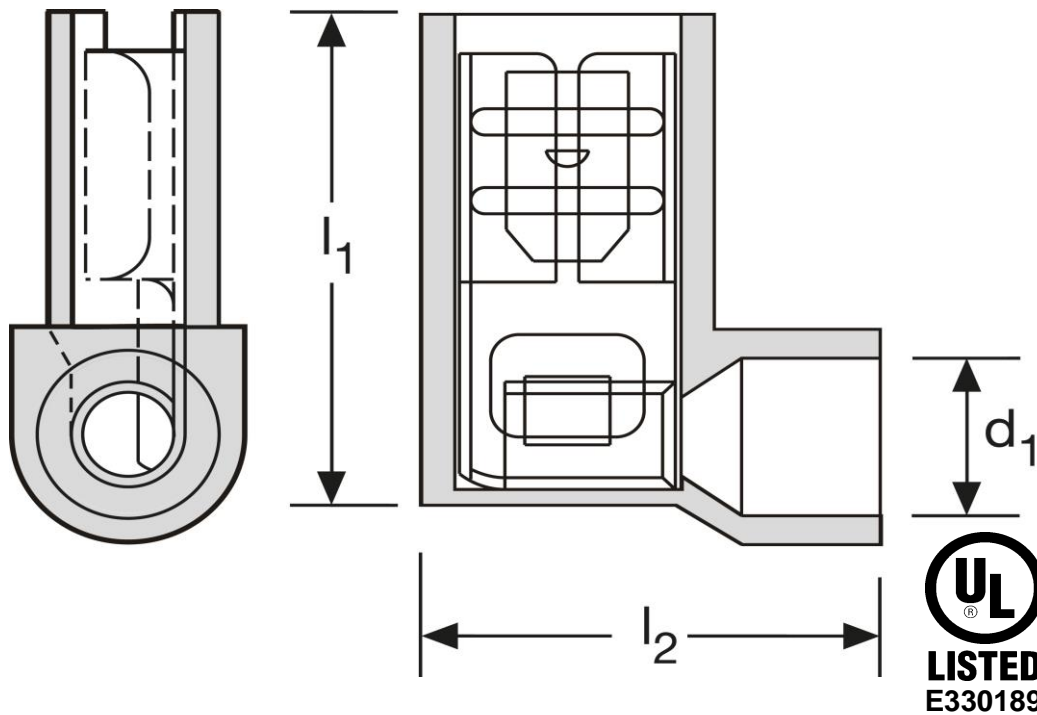
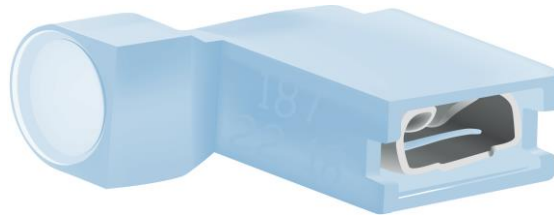

Winkelflachsteckhülsen

easy entry

2,5 mm²

kurze Ausführung



Art.Nr.	Werkstoff	Isolation	
F 614488	Ms gal. Sn	PA 66	1.000
	l₁	l₂	d₁
in mm:	15,2	13,4	5,0
			Steckgröße
			4,8 - 0,8

Stand: 10.03.2016