

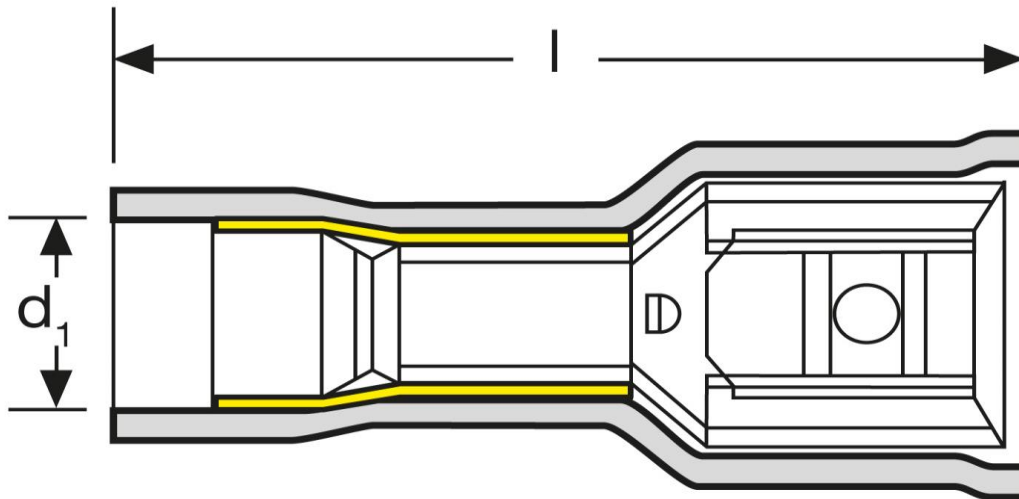

Flachsteckhülsen
vollisoliert
1,5 mm²
rot



Art.Nr.	Werkstoff	Isolation	
F 610285D	Ms, E-Cu gal. Sn	PVC	1.000
	l	d₁	s
in mm:	20,5	4,1	0,25
			Steckgröße
			2,8 - 0,5

Stand: 18.11.2015

Female disonnects
fully insulate
1,5 mm²
red

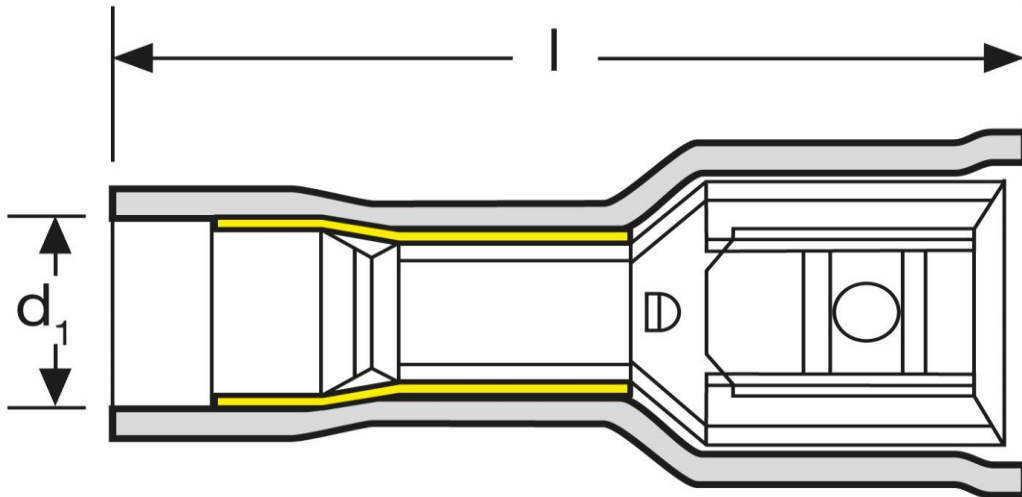

part no.	material	insulation	
F 610285D	Ms, E-Cu gal. Sn	PVC	1.000
	l	d₁	s
in mm:	20,5	4,1	0,25
			tab-size
			2,8 - 0,5

date: 18.11.2015