

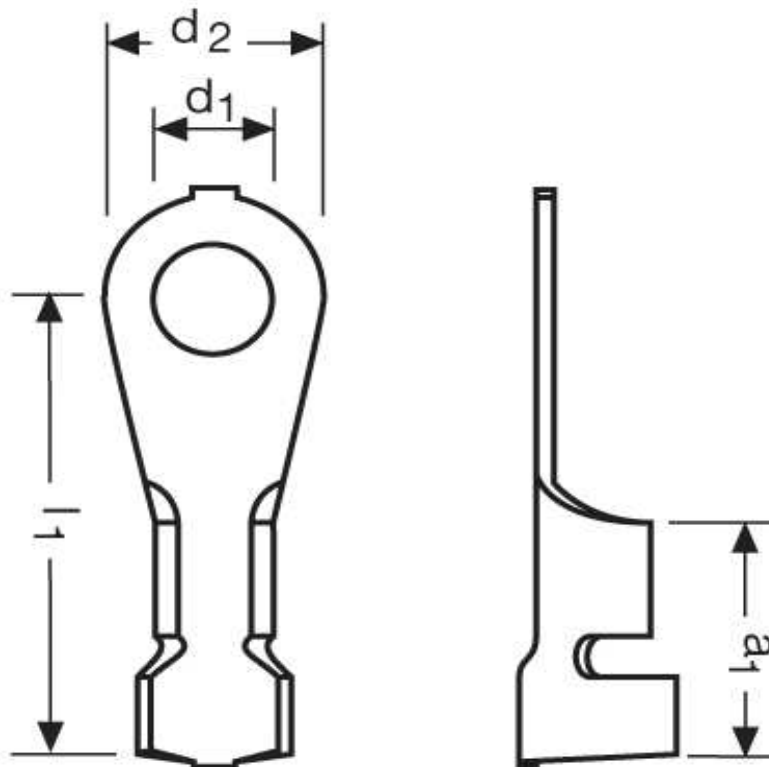

Krallen-Kabelschuhe

1,5 - 2,5 mm² M 4



Katalogseite: 4.16

Art.Nr.	Werkstoff	Oberfläche		
F 53204012	Messing	verzinkt	0,85/1000	1.000
	l1	a1	d1	d2
in mm:	18,3	9,0	4,30	8,00