

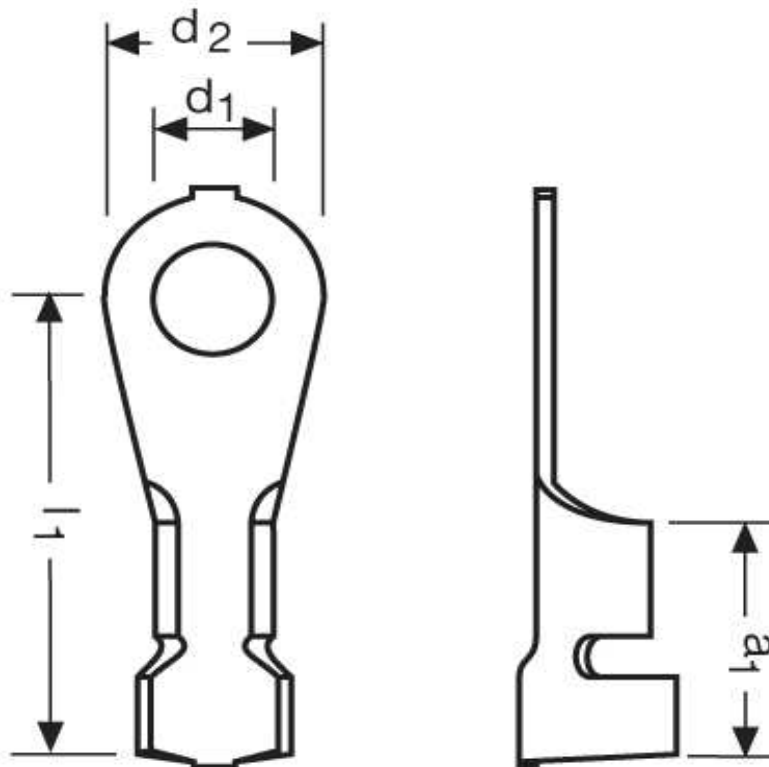

Krallen-Kabelschuhe

0,5 - 1,0 mm² M 6



Katalogseite: 4.16

Art.Nr.	Werkstoff	Oberfläche		
F 53106012	Messing	verzinkt	0,95/1000	1.000
	l1	a1	d1	d2
in mm:	22,0	9,0	6,50	12,00