

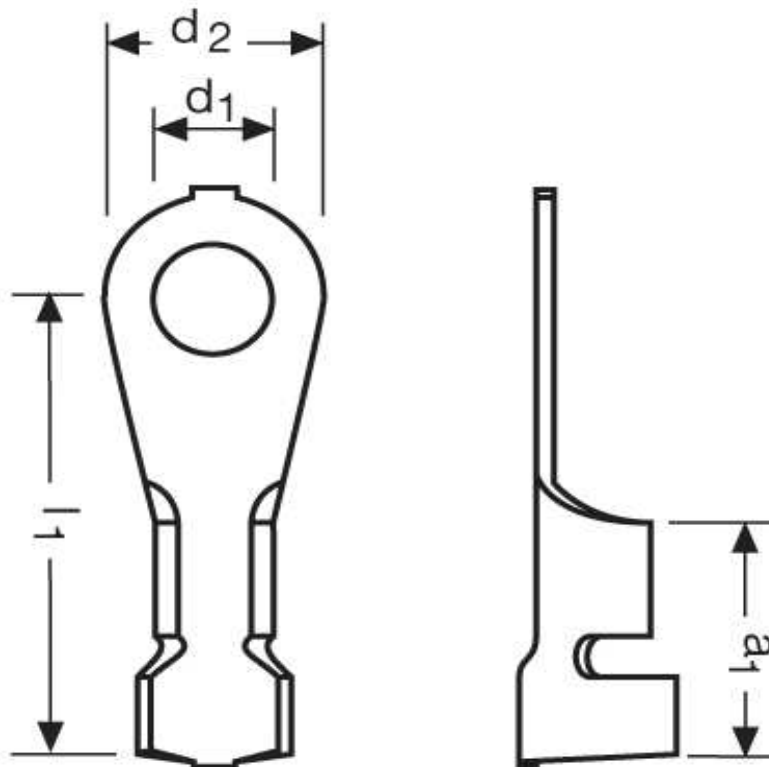

Krallen-Kabelschuhe

0,5 - 1,0 mm² M 5



Katalogseite: 4.16

Art.Nr.	Werkstoff	Oberfläche		
F 53105012	Messing	verzinkt	0,76/1000	1.000
	l1	a1	d1	d2
in mm:	17,5	9,0	5,30	9,50